

## OBC-35\*35

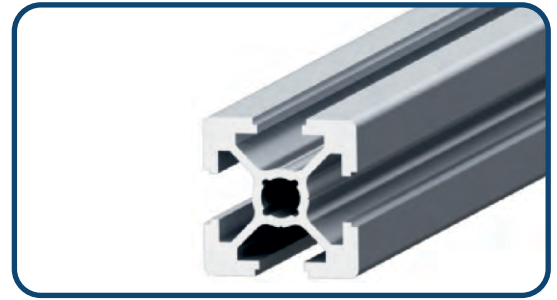

Part No.	Wy cm <sup>3</sup>	Wx cm <sup>3</sup>	Ly cm <sup>4</sup>	Lx cm <sup>4</sup>	L mm	coating	Material	Area cm <sup>2</sup>	Weight kg/m
OBC-35*35	3.8	3.8	6.7	6.7	6000	Anodizad	AL-6063	4.92	1.29

L(Standard) : 6050 mm

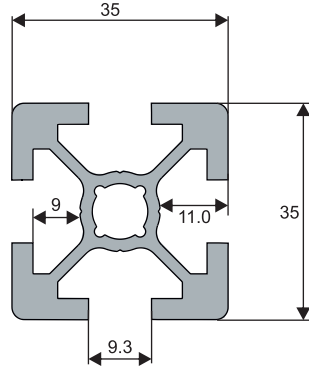
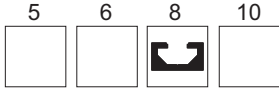

