

## H300 Series

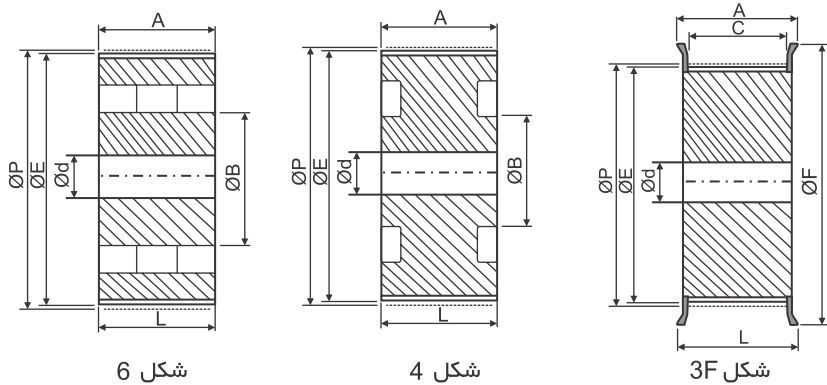

شکل 6

شکل 4

شکل 3F

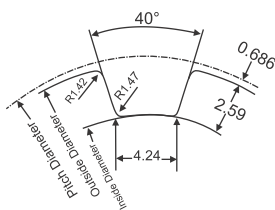

فرم دندانه

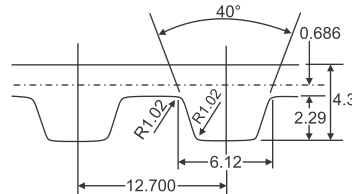

فرم تسمه

H300 با گام ۱۲.۷ میلی‌متر برای تسمه با پهنای ۷۶ میلی‌متر

Unit : mm

Part No.	Teeth No.	Fig.	ØP	ØE	ØF	A	C	L	ØB	Ød	Flange	Material
14-H300	14	3F	56.60	55.23	63.0	85	81	85	42	14	With Flanges	Aluminium
15-H300	15	3F	60.64	59.27	66.5	85	81	85	45	14		
16-H300	16	3F	64.68	63.31	69.5	85	81	85	45	14		
17-H300	17	3F	68.72	67.35	74.5	85	81	85	45	14		
18-H300	18	3F	72.77	71.40	79.5	85	81	85	55	14		
19-H300	19	3F	76.81	75.44	82.5	85	81	85	60	14		
20-H300	20	3F	80.85	79.48	86.0	85	81	85	62	14		
21-H300	21	3F	84.89	83.52	90.5	85	81	85	65	14		
22-H300	22	3F	88.94	87.57	95.5	85	81	85	68	14		
23-H300	23	3F	92.98	91.61	98.5	85	81	85	72	14		
24-H300	24	3F	97.02	95.65	103.5	85	81	85	72	18		
25-H300	25	3F	101.06	99.69	105.0	85	81	85	72	18		
26-H300	26	3F	105.11	103.74	111.0	85	81	85	80	18		
27-H300	27	3F	109.15	107.78	114.5	85	81	85	80	18		
28-H300	28	3F	113.19	111.82	119.0	85	81	85	80	18		
29-H300	29	3F	117.23	115.86	127.0	85	81	85	80	18		
30-H300	30	3F	121.28	119.91	127.0	85	81	85	80	18		
32-H300	32	3F	129.36	127.99	135.0	85	81	85	80	18		
33-H300	33	3F	133.40	132.03	140.0	85	81	85	80	18		
34-H300	34	3F	137.45	136.08	140.0	85	81	85	80	18		

فروشنده حق تغییرات مشخصات فنی و ابعاد را بدون اطلاع قبلی دارد



تلفن : (021) 33913364 - 33951660

فکس : (021) 33985603

## H300 Series

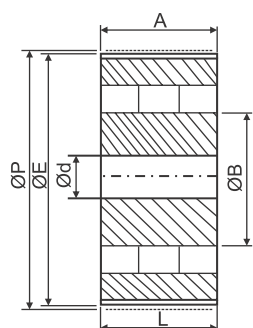

شکل 6

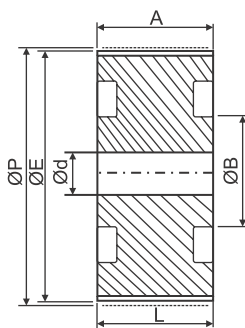

شکل 4

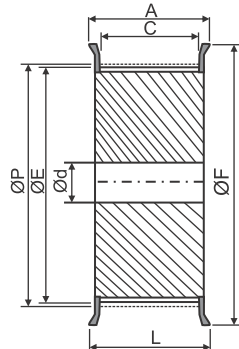

شکل 3F

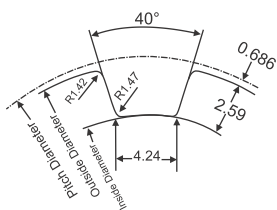

فرم دندانه

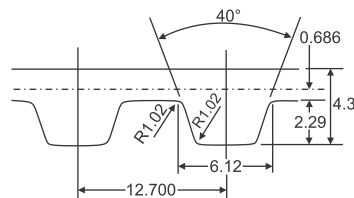

فرم تسمه

H300 با گام ۱۲.۷ میلی‌متر برای تسمه با پهنای ۷۶ میلی‌متر

Unit : mm

Part No.	Teeth No.	Fig.	ØP	ØE	ØF	A	C	L	ØB	Ød	Flange	Material
35-H300	35	3F	141.49	140.12	151.0	85	81	85	80	18	With Flanges	Aluminium
36-H300	36	3F	145.53	144.16	151.0	85	81	85	80	24		
38-H300	38	3F	153.62	152.25	160.0	85	80	85	80	24		
40-H300	40	3F	161.70	160.33	169.0	85	80	85	80	24		
44-H300	44	3F	177.87	176.50	183.0	85	80	85	-	24		
45-H300	45	3F	181.91	180.54	189.0	85	80	85	-	24		
48-H300	48	3F	194.04	192.67	200.0	85	80	85	-	24	With Flanges	
49-H300	49	4	198.08	196.71	-	85	-	85	110	24		
50-H300	50	4	202.13	200.76	-	85	-	85	110	24		
52-H300	52	4	210.21	208.84	-	85	-	85	110	24		
58-H300	58	4	234.47	233.10	-	85	-	85	110	24		
60-H300	60	4	242.55	241.18	-	85	-	85	110	24		
72-H300	72	6	291.06	289.69	-	85	-	85	110	24		
84-H300	84	6	339.57	338.20	-	85	-	85	110	24		
96-H300	96	6	388.08	386.71	-	85	-	85	120	24		
120-H300	120	6	485.10	483.73	-	85	-	85	120	24		
156-H300	156	6	630.63	629.26	-	85	-	85	130	24		

فروشنده حق تغییرات مشخصات فنی و ابعاد را بدون اطلاع قبلی دارد

