

Splitter- passiv distributor

1) General functionalities

The DLS SCHMIERSYSTEME Splitter work according the principle throttle principle. They will be installed between the distributor – DLS FlexxPump or manual hand press - and the lubrication points. The fluid is pumped through an inlet into antechamber. If a pressure of approx. 12 bar is reached after a successive build-up of pressure, the fluid escapes evenly into outlet bores (depending on the type of Splitter: 2, 3- or max. 4 outlets). In each outlet hole is in each case a dowel pin, which holds a gap of 1/10 mm for the fluid open. Check valves in front of each outlet prevent the backflow of fluid from the lubrication points into the splitter.

Depending on the pressure differences at the outlets, slightly different dosing quantities may occur during dispensing

2) Technical drawing

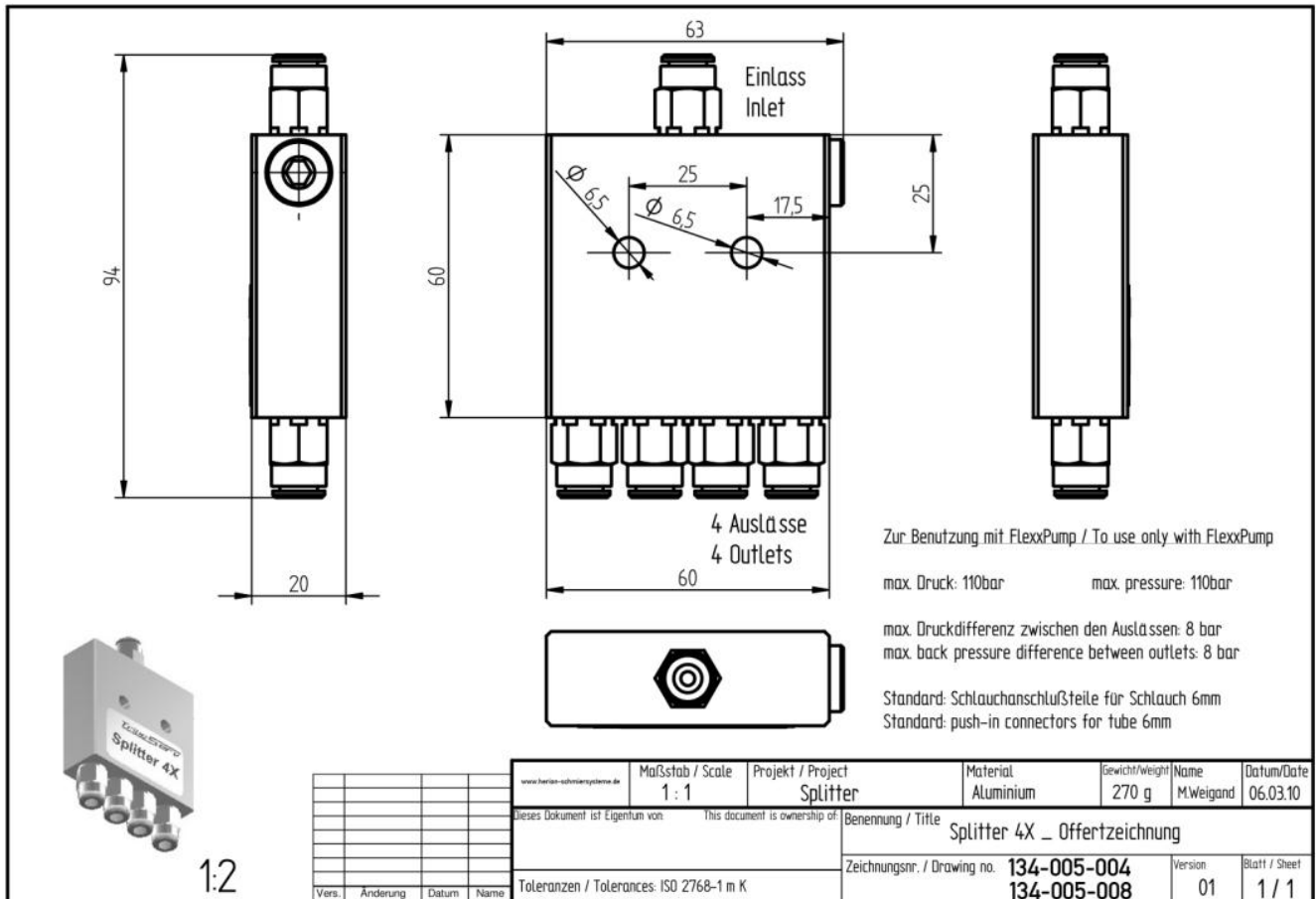

picture 1: 4-outlet Splitter. In this drawing with outlets 6/4 mm tube!



3) General conditions and restrictions

It is important to pay attention to the smallest possible differences when connecting the lubrication points with the outlets. Pressure differences between the outlets must not exceed 8 bar. Please note, connecting the outlet with tubes, the tubes should have the same length and section.

The Splitter can be used for oils and greases up to NLGI 2 and the temperature range is + 10°C - + 60°C.

4) Manually fill the Splitter

Please note additional to Point 3 following information:

- Maximal pressure: 110 bar
- Small dosage volume
- Slow forcing the fluid
- The inlet should be resealed after the fluid has been added
- Ensuring against ingress of foreign matter into the
- Do not install splitter in series



Progressive distributors-disc construction

Version 20151117

Progressive distributors are built for DLS in a variable disk construction. Progressive systems distribute the lubricant progressively via a follower piston control. Simple function control of the progressive distributor is easily monitored by the **FlexxPump**.

The different metering volume per stroke is effected by different piston diameters. A progressive distributor needs at least three pistons. Progressive distributors have an initial element with mounting wholes and a connection thread M10x1 for the inlet. All other elements have a connection thread M10x1 for the outlets.

Technical data

Operating pressure - inlet: 10 to max. 300 bar (4,300 psi)

Temperature range: -10°C to 80°C

Lubricant: oil - fluid grease - grease up to NLGI class 2, unsuitable greases containing solid lubricants

Material: steel, galvanized

DLS experience:



Reliability and safety of progressive distributors can be secured by using the recommended settings and selected lubricants towards pumpability and bleeding like all greases and oils from DLS up to NLGI class 2.

Examples available designs

Progressive distributor S3 Part.-No.: 200373398

High operating reliability :
min. 0,3 cm³ delivery rate
of one period
Setting FlexxPump:
2 strokes with 0,15 cm³

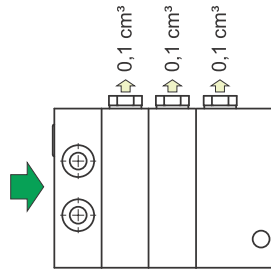

Progressive distributor S4 Part.-No.: 200373399

High operating reliability :
min. 0,45 cm³ delivery rate
of one period
Setting FlexxPump:
3 strokes with 0,15 cm³

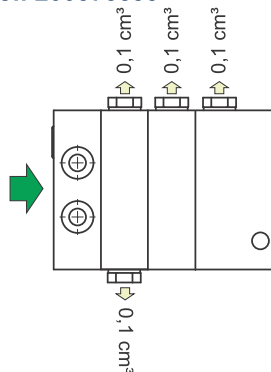

Progressive distributors-disc construction
Progressive distributor S5 Part.-No.: 200373404

Version 20151117

High operating reliability :
min. 0,6 cm³ delivery rate
of one period
Setting FlexxPump:
4 strokes with 0,15 cm³

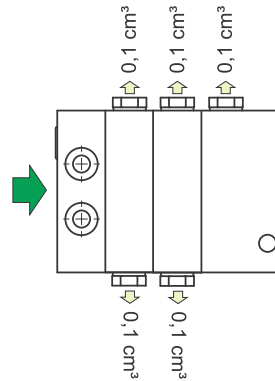

Progressive distributor S6 Part.-No.: 200373400

High operating reliability :
min. 0,6 cm³ delivery rate
of one period
Setting FlexxPump:
4 strokes with 0,15 cm³

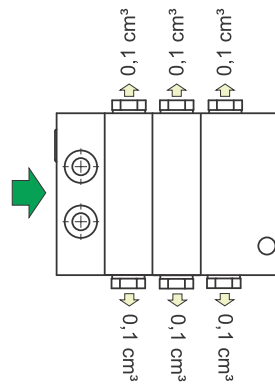

Progressive distributor S7 Part.-No.: 200373405

High operating reliability :
min. 0,75 cm³ delivery rate
of one period
Setting FlexxPump:
5 strokes with 0,15 cm³

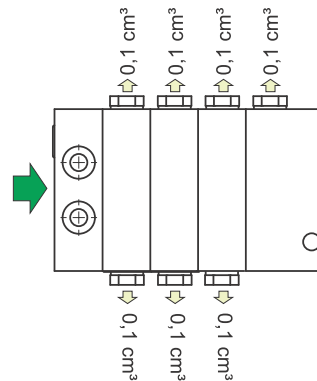

Progressive distributor S8 Part.-No.: 200373401

High operating reliability :
min. 0,75 cm³ delivery rate
of one period
Setting FlexxPump:
5 strokes with 0,15 cm³

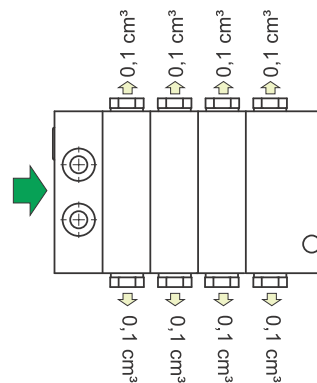

Other models available on request!



Progressive distributors

Version 20151117

Dimension drawing:

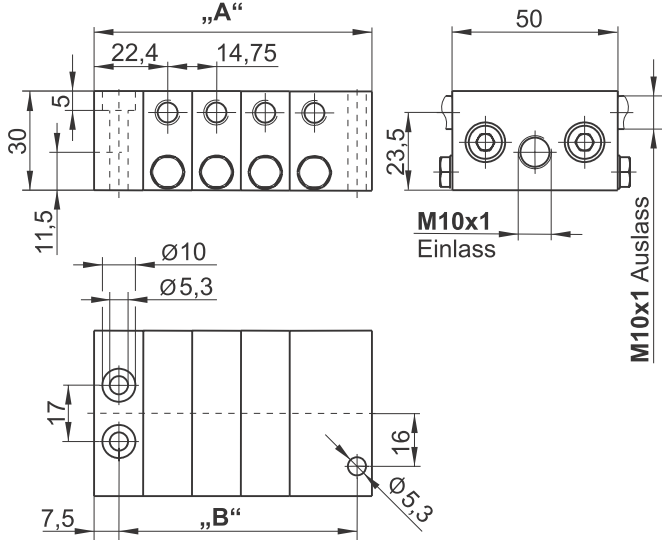

name	number of outlets	„A“ (mm)	„B“ (mm)
S 3	3	69,20	57,2
S 4	4	69,20	57,2
S 5	5	69,20	57,2
S 6	6	69,20	57,2
S 7	7	83,95	72,0
S 8	8	83,95	72,0

Mounting / Installation of the distributor

Note: Please always install the progressive distributors with the pistons in horizontal position.

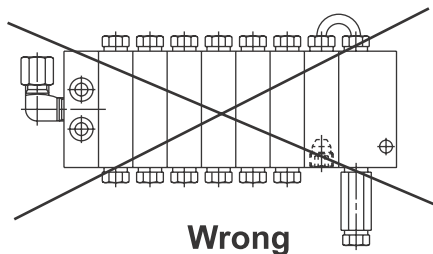
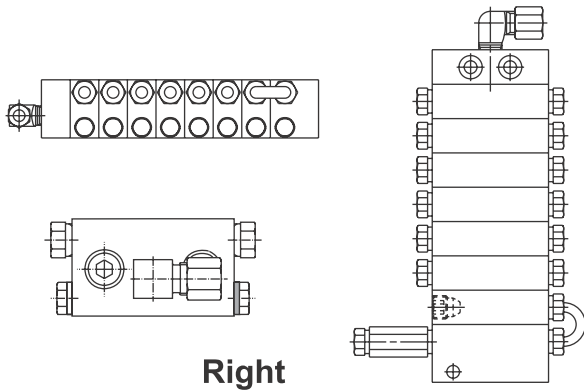

The surface has to be even and free of anything that could possibly lead to tensions.

Standard delivery:

- ready to use, without tube fittings
- equal amounts at the outlets



5.1 Distributors - Splitter

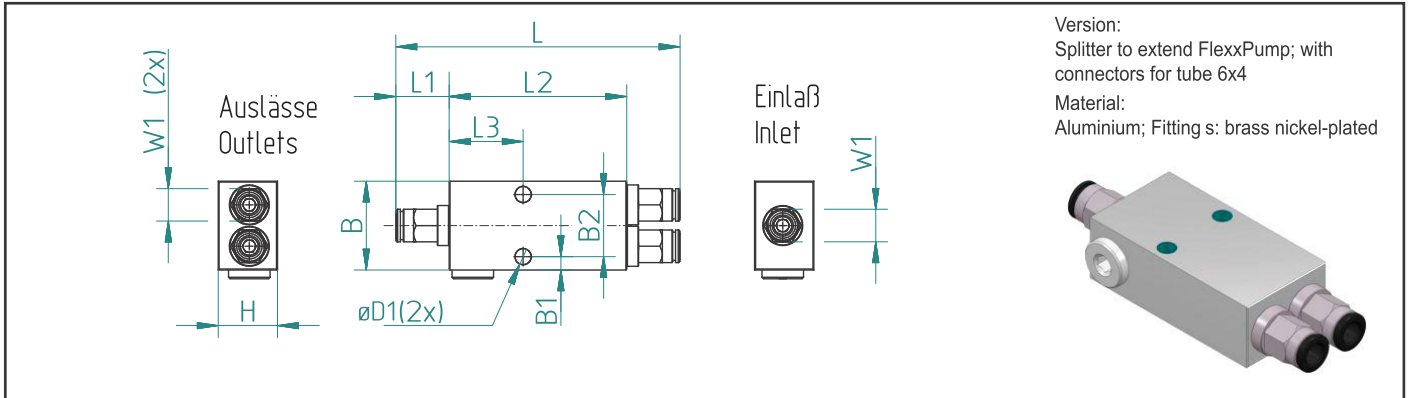

Anzahl Auslässe	Schmierstoff	L	L1	L2	L3	B	B1	B2	H	D1	W1	Artikel-Nr.
Number Outlets	Lubricant											Part-No.
2	Grease	96	(18)	60	25	30	4,5	21	20	5,5	11	134-005-002
3	Grease	96	(18)	60	25	48	18	15	20	6,5	11	134-005-003
4	Grease	96	(18)	60	25	60	17,5	25	20	6,5	11	134-005-004

Notes:

Using splitters only according to specification for each splitter-type.

Splitters are used to delivered with tube-connectors for hoses 6mm outer diameter; the distance to the outlets of the FlexxPump should be as small as possible.
Each outlet of FlexxPump can be connected with exactly one splitter. Depending of FlexxPump type up to 16 (FlexxPump 400 / 500) or up to 40 (FlexxPump 1500 / 2000) or up to 4 (FlexxPump 125) lubrication points can be fed with one FlexxPump. To connect splitters in a row is not possible.
Pressure differences between the outlets should not exceed 8 bar. Therefore, the used tubes should preferably have similar length and same profile.

Splitters are applicable for oil and g rease up to NLGI 2.

Temperature rang e +10°C...+60°C

The amount of lubricant is evenly divided between the outlets.

When using lubricant with solid-particles: **No** use of Splitters!

Depending on the present pressure differences at the outlets, the supplied amounts of lubricant can be slig htly different.

Special desig n on demand.



5.2 Distributors - Progressive Distributors

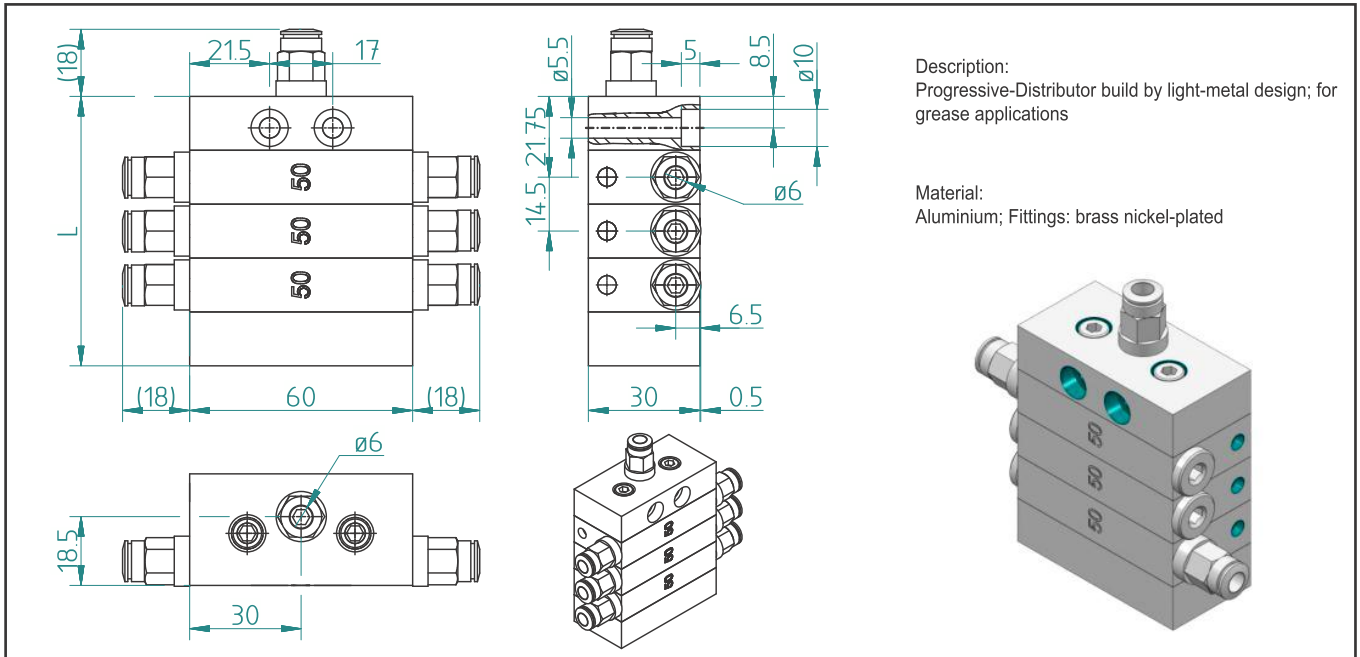

Anzahl Auslässe	Einlass	Schlauch	Auslässe	Schlauch	L	Artikel-Nr.
Number Outlets	Inlet	tube	outlets	tube		Part-No.
2	straight	6x4	straight	6x4	72,5	138-000-002
3	straight	6x4	straight	6x4	72,5	138-000-003
4	straight	6x4	straight	6x4	72,5	138-000-004
5	straight	6x4	straight	6x4	72,5	138-000-005
6	straight	6x4	straight	6x4	72,5	138-000-006
7	straight	6x4	straight	6x4	87,0	138-000-007
8	straight	6x4	straight	6x4	87,0	138-000-008
9	straight	6x4	straight	6x4	101,5	138-000-009
10	straight	6x4	straight	6x4	101,5	138-000-010
11	straight	6x4	straight	6x4	116,0	138-000-011
12	straight	6x4	straight	6x4	116,0	138-000-012
13	straight	6x4	straight	6x4	130,5	138-000-013
14	straight	6x4	straight	6x4	130,5	138-000-014

Standard:

- modular progressive-distributor for FlexxPump 125 / 400 / 1500; to be used with grease
- from 2 up to 14 outlets
- washers with different metered volume
- Distributor elements with different volumes for equal amount per outlet
- Tube connectors for tube 6x4 straight at inlet and outlets
- maximum pressure 100 bar

Special design (on demand):

- tube-connectors with various designs (straight / elbow) for tubes with several dimensions (4 / 6 / 8) for inlet and / or outlets
- Position of outlets
- Different volumes per outlet
- higher pressure / oil version
- controlled by proximity switch

Notes:

- Use with convenient lubricants only
- Temperature range: +10°C...+60°C
- No cascading of different distributors with FlexxPump 125 / 400 / 1500.

