

Datasheet of the Easy Servo Drive *ES-D1008*

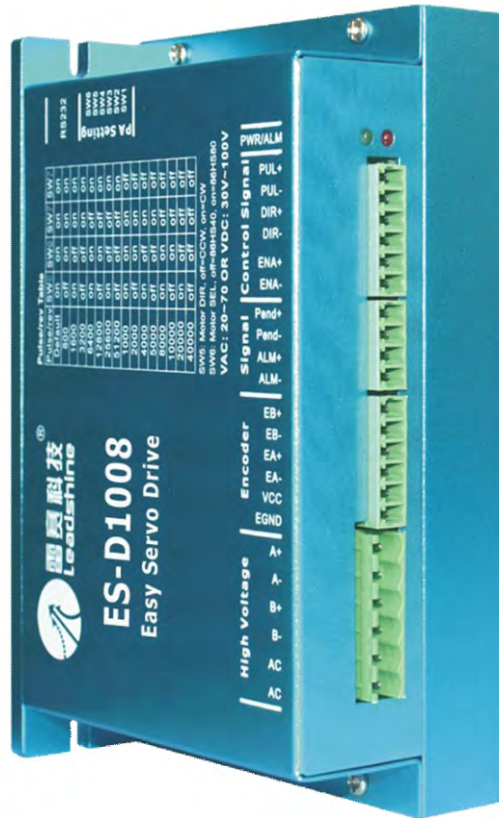

20-70 VAC or 30-100VDC, 8.2A Peak, Close-loop, No Tuning



Features

- Step and direction control
- Closed position loop for no loss of movement synchronization
- Operating voltage: 20-70 VAC or 30-100VDC
- Load based output current of 0.5 - 8.2 A
- High torque at starting and low speed
- No torque reservation
- High stiffness at standstill
- Significantly reduced motor heating
- Smooth motor movement and extra low motor noise
- Quick response, no delay and zero settling time
- No loss of steps; no hunting; no overshooting
- Plug-and-play and no tuning

Descriptions

ES-D1008 is one of the models in Leadshine ES-D series easy servo drives which can take 20-70 VAC or 30-100 VDC operating voltage, and output 0.5 - 8.2 A continuous load-based current. It is capable of driving NEMA 23, 24 and 34 easy servo motors (stepper motors with encoders) with the position loop closed in real time.

Based on latest DSP technology and adopting Leadshine's advanced control algorithm, ES-D1008 easy servo drive applies servo control on easy servo motors. When adopted with an easy servo motor, it combines features of both open loop steppers & brushless servo systems, and offers many unique advanced features for excellent motion control system performance.

When an ES-D1008 easy servo drive is implemented with a Leadshine ES-M series easy servo motor, there is No Configuration Needed for almost all applications. The output resolution from ES-D1008 with the output resolution defaulted to output resolution of 2,000 pulses per resolution (equal to 10 microstep in 2-phase stepper systems). Via DIP switches, a user can also easily changes the output resolution to one of 15 output resolutions 800 to 51,200 (equal to 4-256 microstep in 2-phase stepper systems). With Leadshine configuration software, ProTuner, an advanced user can also set custom settings of resolution, current & position loop parameters, idle current percentage, etc.

Applications

With many unique advanced features, Leadshine ES-D1008 easy servo systems are ideal for many industries to upgrade stepper performance or replace brushless servo systems in many applications.

Leadshine OEM clients have successfully implemented ES-D1008 driven easy servo systems in applications such as small-to-large size CNC routers, CNC mills, plasmas, large-scale laser cutters / engravers, labeling equipments, robotics, gemstone processing machines, pick & place machines, X-Y tables.



Specifications

Electrical Specifications

Parameter	Min	Typical	Max	Unit
Input Voltage	20	-	70	VAC
	30	60	100	VDC
Output Current	0.5	-	8.2(Peak)	A
Pulse Input Frequency	0	-	200	kHz
Logic Signal Current	7	10	16	mA
Isolation Resistance	500	-	-	M

Operating Environment

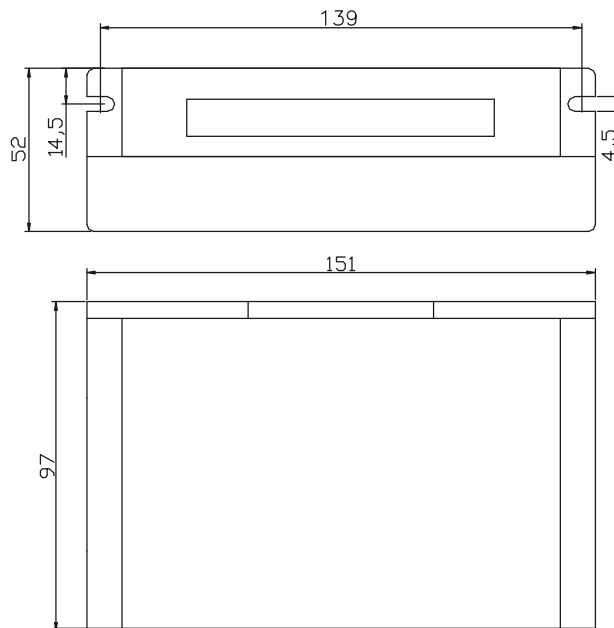

Cooling	Natural Cooling or Forced cooling	
Operating Environment	Environment	Avoid dust, oil fog and corrosive gases
	Storage Temperature	-20°C — 65°C (-4°F — 149°F)
	Ambient Temperature	0°C — 50°C (32°F — 122°F)
	Humidity	40%RH — 90%RH
	Operating Temperature (Heat Sink)	70°C (158°F) Max
Storage Temperature	-20°C — 65°C (-4°F — 149°F)	
Weight	580 g (20.5 oz)	

Mechanical Specifications

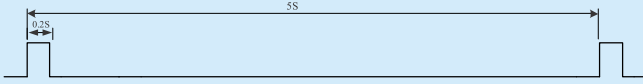
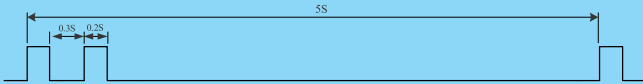

Protection Indications

The green indicator turns on when power-up. When drive protection is activated, the red LED blinks periodically to indicate the errors

Priority	Time(s) of Blink	Sequence wave of RED LED	Description
1st	1		Over-current protection
2nd	2		Over-voltage protection
3rd	7		Position Following Error

Connectors and Pin Assignment

The ES-D1008 has four connectors, connector for control signals connections, connector for status signal connections, connector for encoder feedback and connector for power and motor connections.

Control Signal Connector Screw Terminal			
Pin	Name	I/O	Description
1	PUL+	I	<u>Pulse Signal</u> : In single pulse (pulse/direction) mode, this input represents pulse signal, each rising or falling edge active (software configurable, see easy servo drive software manual for more detail); In double pulse mode (software configurable), this input represents clockwise (CW) pulse, active both at high level and low level. 4.5-24V when PUL-HIGH, 0-0.5V when PUL-LOW. For reliable response, pulse width should be longer than 2.5μs.
2	PUL-	I	
3	DIR+	I	<u>Direction Signal</u> : In single-pulse mode, this signal has low/high voltage levels, representing two directions of motor rotation. In double-pulse mode (software configurable), this signal is counter-clock (CCW) pulse, active both at high level and low level. For reliable motion response, DIR signal should be ahead of PUL signal by 5μs at least. 4.5-24V when DIR-HIGH, 0-0.5V when DIR-LOW. Please note that rotation direction is also related to motor-driver-encoder wiring match. Exchanging both the connection of two wires for a coil and an encoder channel to the driver the connection will reverse motion direction. Or you can toggle the SW5 to reverse the motion direction.
4	DIR-	I	
5	ENA+	I	<u>Enable Signal</u> : This signal is used for enabling/disabling the driver. In default, high level (NPN control signal) for enabling the driver and low level for disabling the driver. Usually left UNCONNECTED (ENABLED) . Please note that PNP and Differential control signals are on the contrary, namely Low level for enabling. The active level of ENA signal is software configurable.
6	ENA-	I	



Connectors and Pin Assignment (Continued)

Status Signal Connector			Screw Terminal
Pin	Name	I/O	Description
1	INP+	O	<u>In-position Signal</u> : OC output signal, active when the difference between the actual position and the command position is zero. This port can sink or source 20mA current at 24V. The resistance between INP+ and INP- is active at high impedance.
2	INP-	O	
3	FAULT+	O	<u>Fault Signal</u> : OC output signal, active when one of the following protection is activated: over-voltage, over current and position following error. This port can sink or source 20mA current at 24V. In default, the resistance between FAULT+ and FAULT- is low impedance in normal operation and become high when the ES-D1008 goes into error. The active level of alarm signal is software configurable.
4	FAULT-	O	

Encoder Feedback Connector			Screw Terminal
Pin	Name	I/O	Description
1	EB+	I	Encoder channel B+ input
2	EB-	I	Encoder channel B- input
3	EA+	I	Encoder channel A+ input
4	EA-	I	Encoder channel A- input
5	VCC	O	+5V @ 100 mA max.
6	EGND	GND	Signal ground

Power and Motor Connector			Screw Terminal
Pin	Name	I/O	Description
1	A+	O	Motor Phase A+
2	A-	O	Motor Phase A-
3	B+	O	Motor Phase B+
4	B-	O	Motor Phase B-
5	AC	I	Power Input, 20-70VAC or 30-100VDC
6	AC	I	



RS232 Communication Port

It is used to configure the close-loop current, open-loop current, position following error limit and etc. See easy servo drive software operational manual for more information.

RS232 Communication Port			
Pin	Name	I/O	Description
1	NC	-	Not connected.
2	+5V	O	+5V power only for STU (Simple Tuning Unit).
3	TxD	O	RS232 transmit.
4	GND	GND	Ground.
5	RxD	I	RS232 receive.
6	NC	-	Not connected.

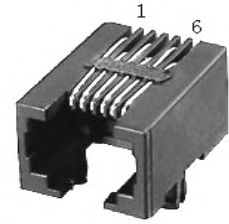

DIP Switch Settings

Microstep Resolution (SW1-SW4)

Steps/Revolution	SW1	SW2	SW3	SW4
Software Configured (Default 200)	on	on	on	on
800	off	on	on	on
1600	on	off	on	on
3200	off	off	on	on
6400	on	on	off	on
12800	off	on	off	on
25600	on	off	off	on
51200	off	off	off	on
1000	on	on	on	off
2000	off	on	on	off
4000	on	off	on	off
5000	off	off	on	off
8000	on	on	off	off
10000	off	on	off	off
20000	on	off	off	off
40000	off	off	off	off



DIP Switch Settings (Continued)

	Function	On	Off
SW5	Default Direction ^{Note}	CW (clock-wise)	CCW (counter-clock-wise)
SW6	Self-test	Self-test is active	Self-test is close

Note: The actual direction is related to the DIR level. You can toggle SW5 to change it once.

Current Control

The motor current will be adjusted automatically regarding to the load or the stator-rotor relationship. However, the user can also configure the current in the tuning software. The configurable parameters include close-loop current, holding current, encoder resolution, micro step and etc. There are also PID parameters for the current loop, and have been tuned for Leadshine's matching motor so the user does not need to tune them.

Easy Servo Motors

The ES-D1008 can work with the following easy servo motors from Leadshine:

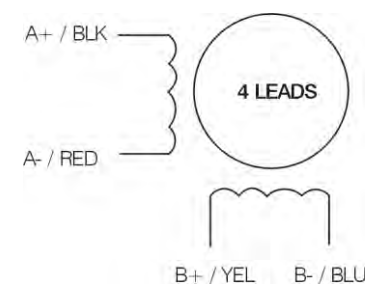
	ES-M23440 ES-M23440-S1270	ES-M23480 ES-M23480-S1270	Wiring Diagram
Step Angle (Degree)	1.8	1.8	 <p>A+ / BLK A- / RED B+ / YEL B- / BLU</p>
Holding Torque (N.m)	4.0	8.0	
Phase Current (A)	5.5	6.0	
Phase Resistance (Ohm)	0.46	0.44	
Phase Inductance (mH)	4	3.73	
Inertia (g.cm ²)	1500	2580	
Weight (Kg)	2.5	4.0	
Encoder (lines / Rev.)	1000	1000	

Motor Encoder Cable Pin-Out

ES-M23440, ES-M23440-S1270, ES-M23480, ES-M23480-S1270

Pin	Name	Wire Color	I/O	Description
1	EA+	Black	O	Channel A+ output
2	VCC	Red	I	+5V power input
3	GND	White	GND	Ground
11	EB+	Yellow	O	Channel B+ output
12	EB-	Green	O	Channel B- output
13	EA-	Blue	O	Channel A- output

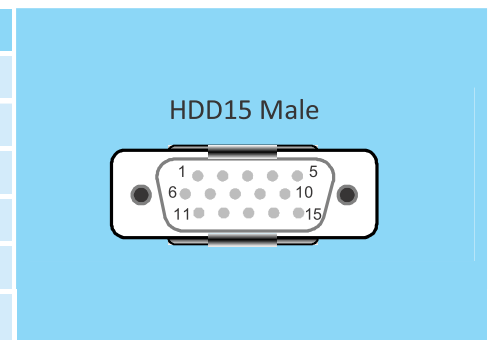

Motor Encoder Extension Cable

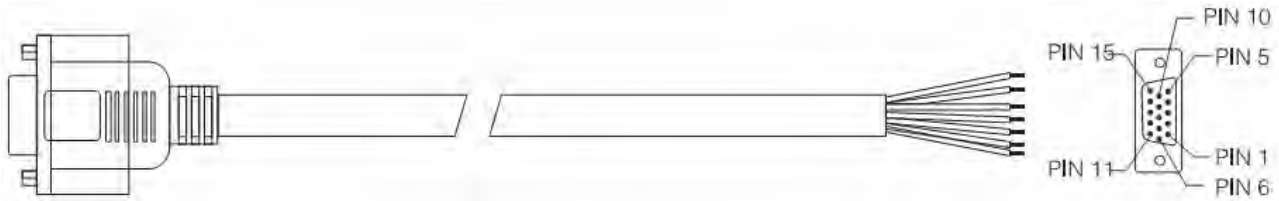

Pin Assignments

Pin	Wire Color	Name	Description	Pin	Wire Color	Name	Description
2	Red	VCC	+5V power input	12	Green	EB-	Channel B-
3	White	GND	+5V GND	1	Black	EA+	Channel A+
11	Yellow	EB+	Channel B+	13	Blue	EA-	Channel A-

Cable Length

Part Number	L	Matching Motor
CABLEH-BM3M0	3.0m	ES-M23440, ES-M23440-S1270, ES-M23480, ES-M23480-S1270
CABLEH-BM5M5	5.5m	
CABLEH-BM8M0	8.0m	
CABLEH-BM10M0	10.0m	
CABLEH-BM13M0	13.0m	

Motor Power Extension Cable

CABLEH-RZXMX

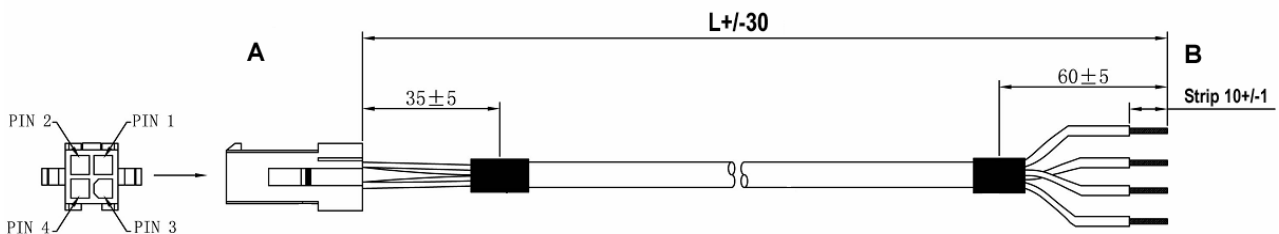

Pin Assignments

A	B	Name	Description
Pin	Wire Color		
1	Blue	B-	Motor Phase B-
2	Red	A-	Motor Phase A-
3	Black	A+	Motor Phase A+
4	Yellow / Green	B+	Motor Phase B+

Cable Length

Part Number	L	Matching Motor
CABLEH-RZ3M0	3.0m	ES-M23440, ES-M23440-S1270, ES-M23480, ES-M23480-S1270
CABLEH-RZ5M0	5.0m	
CABLEH-RZ10M0	10.0m	



Typical Connections

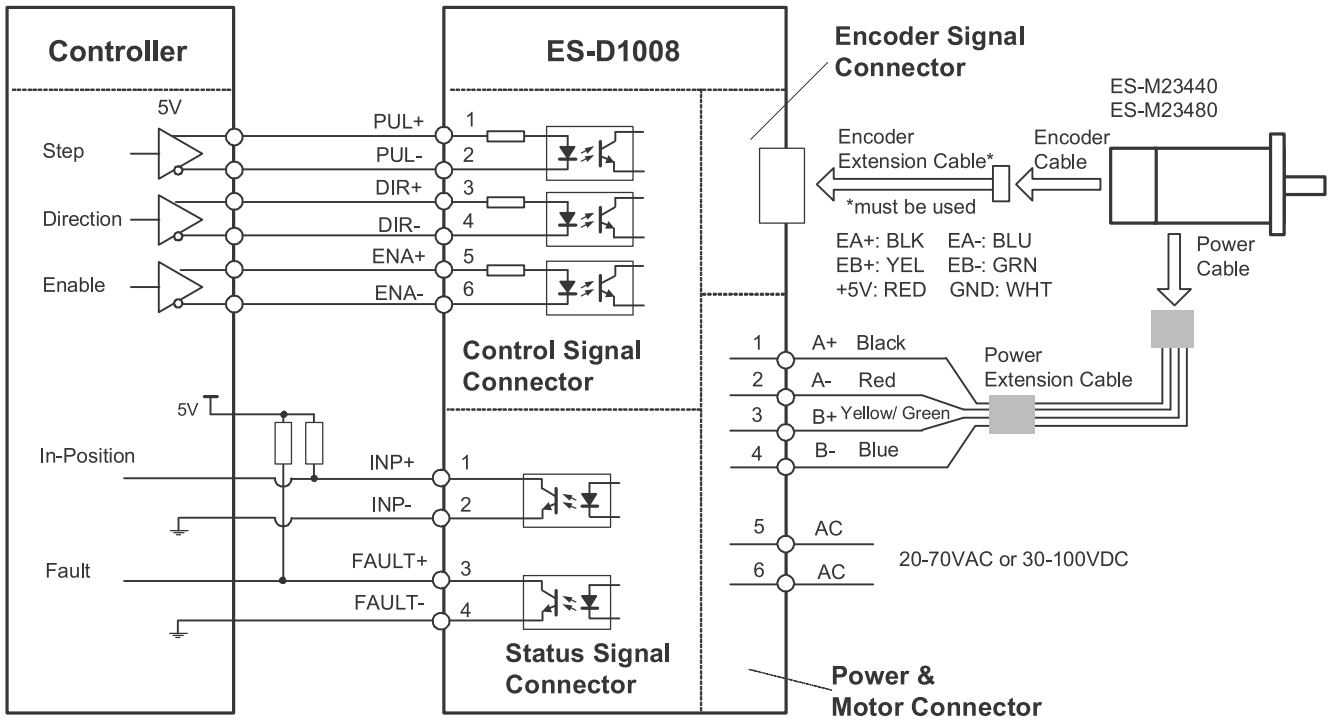

Connections to controller of differential output

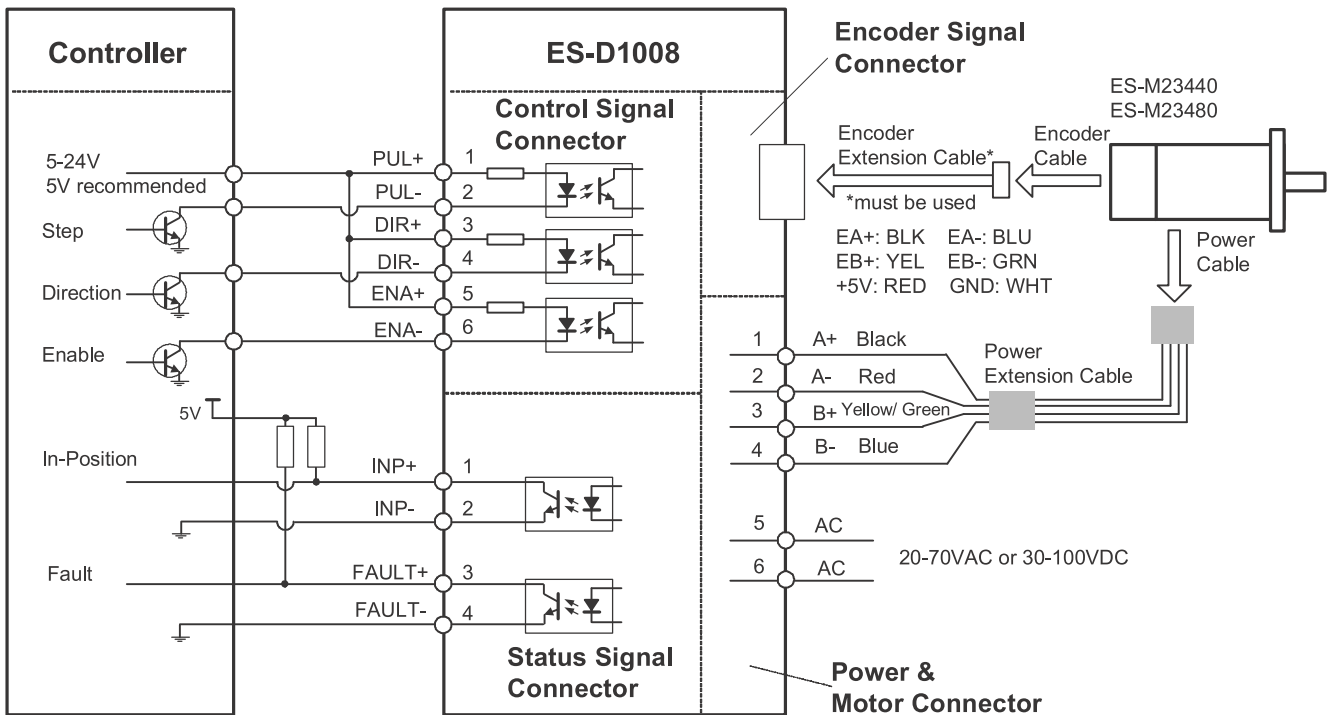

Connections to controller of sinking output



Typical Connections (Continued)

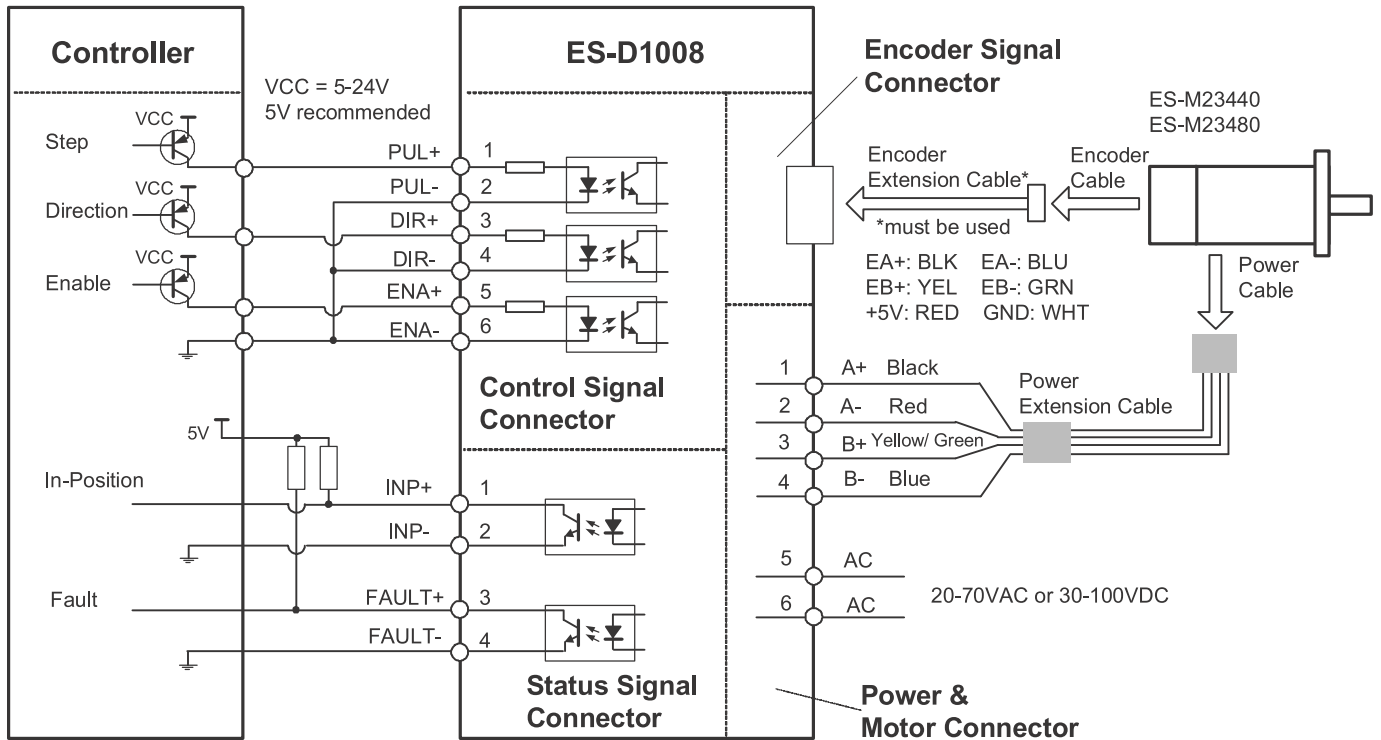

Connections to controller of sourcing output



Software Manual of the Easy Servo Drives

ES-D508, ES-D808, ES-D1008, ES-D1208 & ES-D2306

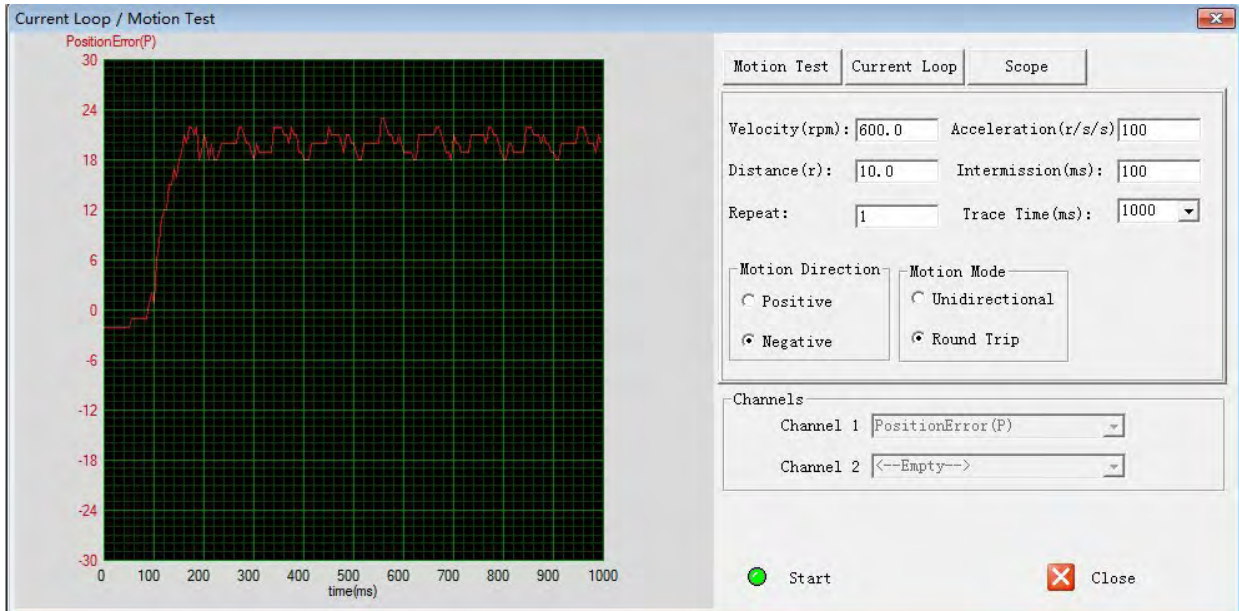

Introduction

The ProTuner is a setup-software that is designed to configure and tune Leadshine s easy servo drives including ES-D508, ES-D808, ES-D1008, ES-DH1208 and ES-DH2306. Users can configure the drive s output current, micro step resolution, command type, tune the current loop and adjust the position loop parameters in this software.

Workspace









Menus and Toolbar

Menus and toolbars are at the top of the workspace. You can click menu bar to view pull-down menu. The toolbar below the menu bar offers the most frequency commands.



Menus and Toolbar (Continued)

Menu	Pull Down	Toolbar	Function
Projects ->	Connect to Drive		Open the serial port and connect to drive
	Exit	-	Exit from ProTuner
Drive Settings->	Inputs / Outputs		Set the command type, active level of the I/O signal.
	Current Loop / Motion Test		Tune the current loop and perform Motion Test.
	Save Drive Parameters		Write the parameters to the drive's NVM (Non-volatile Memory).
	Reset	-	Reset all settings.
Motor Settings->	Motor Settings		Set micro step resolution, position following limit and encoder resolution.
Tools->	Drive Parameters		Download / upload data between the ProTuner and the drive. Or you can also save parameters to a file and restore parameters from a file.
	Alarms		Check drive alarms
About->	ProTuner Information		Display ProTuner information



Using the Software

Connecting Drive

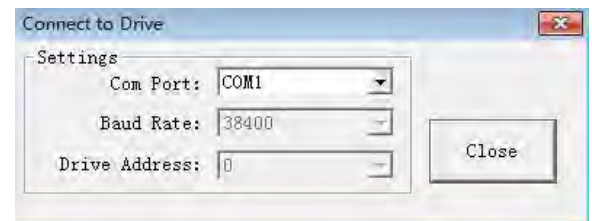
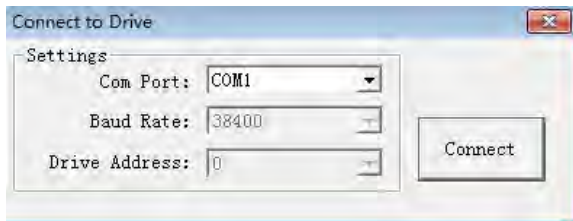

The **Connect to Drive** window will appear when you open ProTuner. You can also open it by clicking **Projects->Connect To Drive** when the software is open. . Select the serial port number and click on the **Connect** button. The software will try to connect to the drive and read the settings. It may take several minutes.



Before connecting the drive, please make sure:

- 1) The RS232 cable .has been connected between the drive and PC serial port.
- 2) Power has been applied to the drive and the green LED is turned on.

Connect to the motor is not necessary if you just want to change the parameters.



Do not connect or disconnect serial cable when drive is powered on. The drive s communication circuit may be damaged.

Inputs/Outputs Window

Click **Drive->Inputs/Outputs** to open the inputs/outputs configuration window. In this window, you can select the active edge of the pulse input, control mode, the active impedance of the In-position output, the active impedance and fault output and the active level of the enable input. Click **Download** to update the parameters on-line.

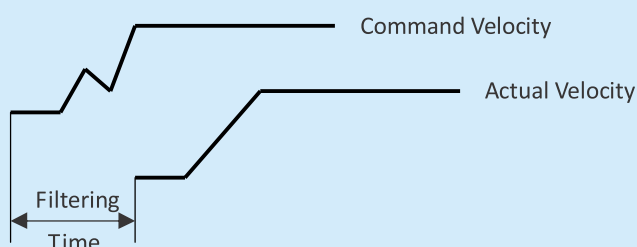

Inputs/Outputs Window (Continued)

Item	Description	Value
Active Edge	Pulse active edge. The motor shaft moves one micro step on each active edge of the pulse.	Rising /Falling
Pulse Mode	Pulse mode of control signal. Select PUL/DIR or CW/CCW according to command type of motion controller. PUL/DIR means pulse and direction mode; CW/CCW means double pulses mode.	PUL/DIR CW/CCW
Fault Output	Active impedance of the fault output. Active High means the impedance between ALM+ and ALM- is high when the drive goes into fault.	Active High / Active Low
Enable Control	Specify the active level of the enable input.	Low level / High level
Filtering Enable	Enable / Disable the internal command filter (or smoother). Note that it will enable the internal command filter.	-
Filtering Time	The time to smooth the command. 	50-25600 us



Current loop / Motion Test Window

Click **Drive->Current loop/ motion test window** to open this window. You can adjust the current loop Kp (proportional gain) and Ki (integral gain) in this window. You can also rotate the motor shaft in this window.

Motion Test Tab

In the Motion Test tab, you can make the motor move without an external motion controller. Set the trapezoidal velocity profile first and then click the **Start** button.

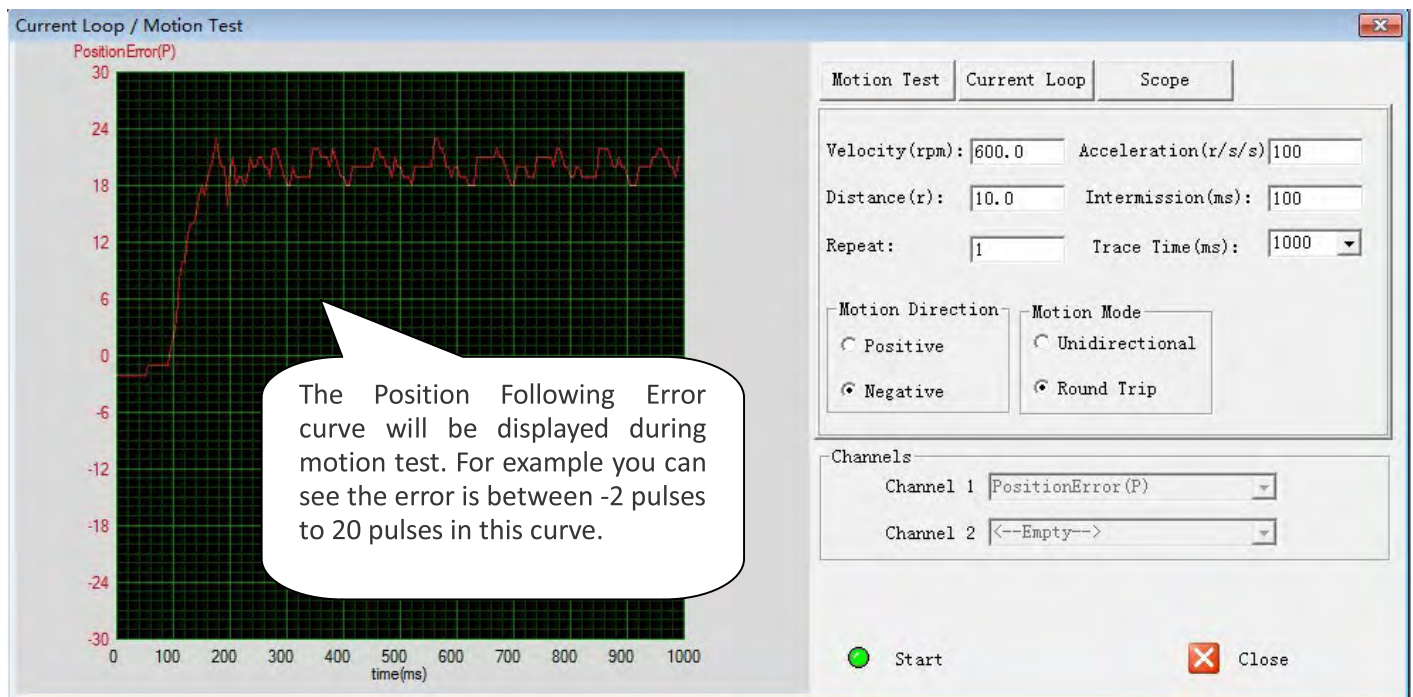

Motion Test Tab (Continued)

Illustration to the parameters in the motion test tab

Item	Description	Value
Velocity (rpm)	Target velocity of Motion Test.	1 – 5000 rpm
Acceleration (r/r/s)	Acceleration of Motion Test.	1 – 3000 r/s ²
Distance (r)	Move distance of Motion Test.	1 – 655 r
Intermission (ms)	Interval between moves.	1 – 10000 ms
Repeat	Repeat times.	1 – 65535
Motion Direction	Move direction of the motion.	Positive/ Reversal
Motion Mode	Motion Test mode includes single direction motion or two direction motion. Unidirectional: Run in one direction, Round Trip: Run forward and back	Unidirectional / Round Trip
Trace Time	The time to sample the position following error data.	100 – 3000 ms
Start	Click to start the Motion Test.	-
Stop	Stop the move immediately.	-
Close	Close the Current / Motion test window	-

The following figures illustrate how the trapezoid motion profile is constructed:

1. Motion Mode: Round Trip

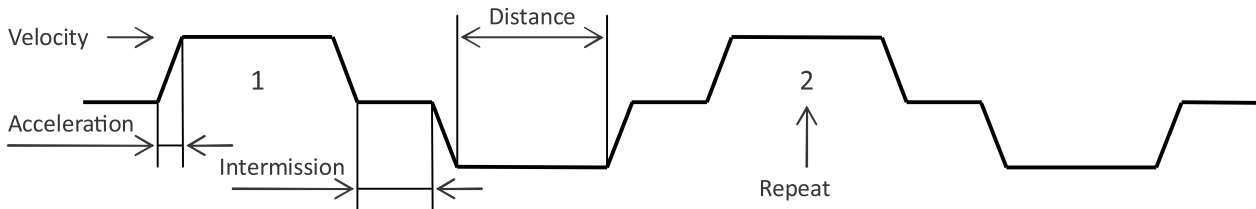

2. Motion Mode: Unidirectional

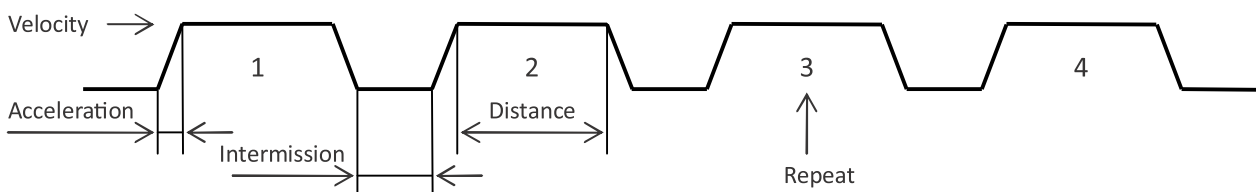

Current Loop Tab

Click **Current Loop** tab to open this window. The current loop parameter is related to the motor resistance and inductance.



If the **Current loop Auto-configuration** is checked, the Kp and Ki will be calculated automatically at power-up. In such case this window is just for check for them. The result of the **Current loop Auto-configuration** is good enough for most of the application.

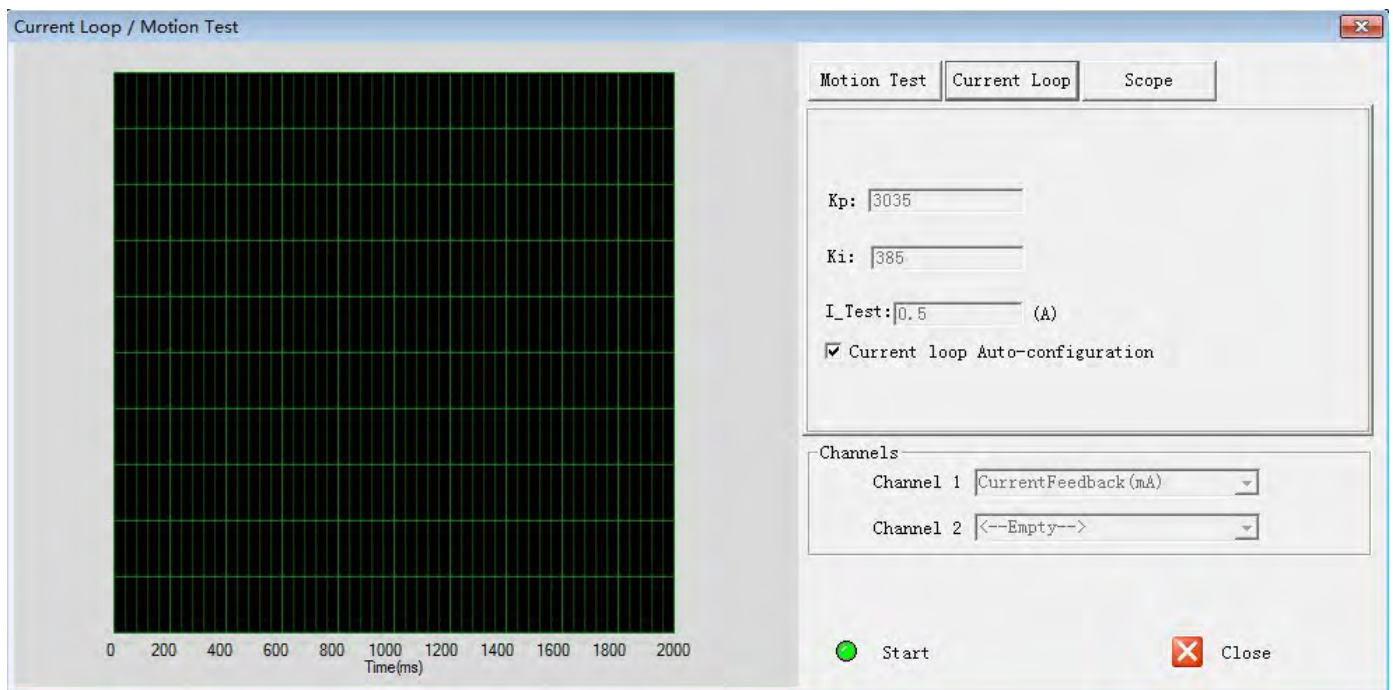

The screenshot shows a software window titled "Current Loop / Motion Test". It features three tabs: "Motion Test", "Current Loop" (which is selected), and "Scope". The "Current Loop" tab contains the following settings:

- Kp: 3035
- Ki: 385
- I_Test: 0.5 (A)
- Current loop Auto-configuration

Below these settings is a "Channels" section with two dropdown menus:

- Channel 1: CurrentFeedback (mA)
- Channel 2: <--Empty-->

At the bottom of the window, there are two buttons: a green "Start" button and a red "Close" button. On the left side of the window, there is a large black area with a green grid, which is currently empty, suggesting a scope or plot area.



Current Loop Tab (Continued)

Illustration to the current loop parameters Kp and Ki

Item	Description	Value
Current Loop Kp (Proportional Gain)	Increase Kp to make current rise fast. Proportional Gain determines the response of the drive to current setting command. Low Proportional Gain provides a stable system (doesn't oscillate), has low stiffness, and large current error, causing poor performances in tracking current setting command in each step. Too large proportional gain values will cause oscillations and unstable systems.	0 - 32766
Current Loop Ki (Integral Gain)	Adjust Ki to reduce the steady error. Integral Gain helps the drive to overcome static current errors. A low or zero value for the Integral Gain may have current errors at rest. Increasing the integral gain can reduce the error. If the Integral Gain is too large, the systems may hunt (oscillate) around the desired position.	0 - 32766
I-Test (A)	The current amplitude for the step response test. Do not exceed the maximum output current of the drive.	0.5A to 5A
Start	Enter Kp, Ki then click this button to activate the test. A target curve (red) will be displayed on the screen for user analysis.	-



Scope Tab

Click **Scope** tab to open this window. You can check the position following error in this window. When the users run the easy servo system in real applications, this window helps to check the performance.

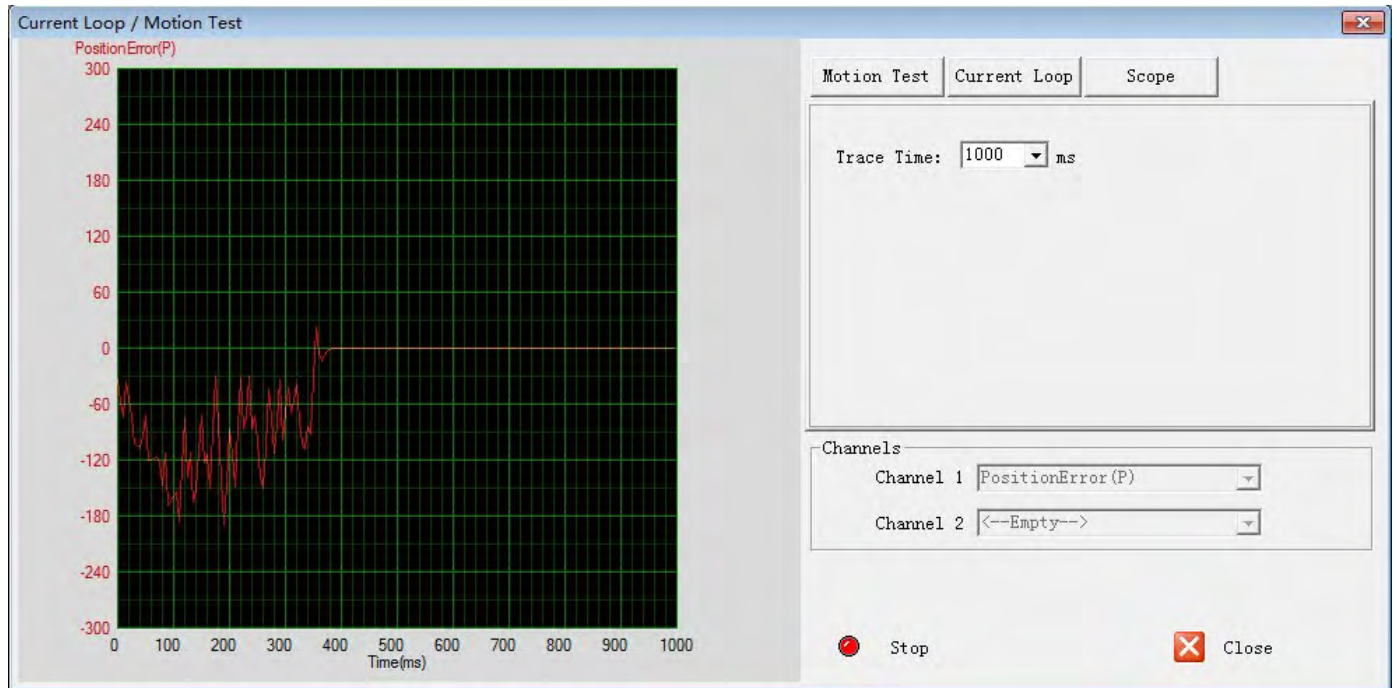

Illustration to the scope parameters settings

Item	Description	Value
Trace Time	The time to sample the position following error. For example, if the trace time is 1000ms, the drive board acquires the position following error data every 1000ms.	100-3000ms
Channel	Select the display signal for each channel. It is depending on the drive model that which curves are available.	-
Start	Start to monitor and display the curves.	-
Stop	Stop monitoring.	-



Save Drive Parameters

The parameter values are only loaded to the drive board's RAM when you change them in ProTuner. After power-off, they will be lost. So you need to click **Drive Settings->Save Drive Parameters** to save all parameters to the drive board's non-volatile memory.

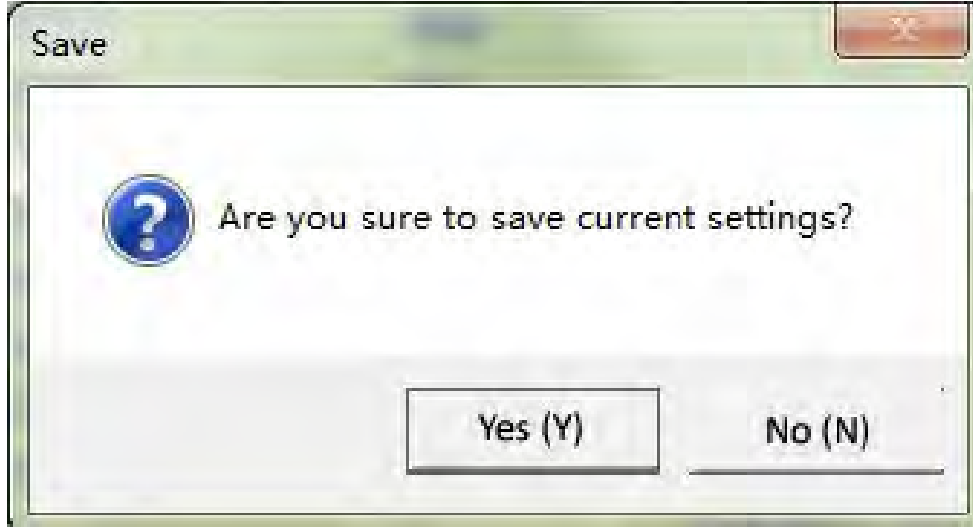

Reset

It is possible that the parameter value is changed unexpectedly and you want to restore the default value. You can click **Drive Settings->Reset** for this purpose. The following confirmation window will appear.

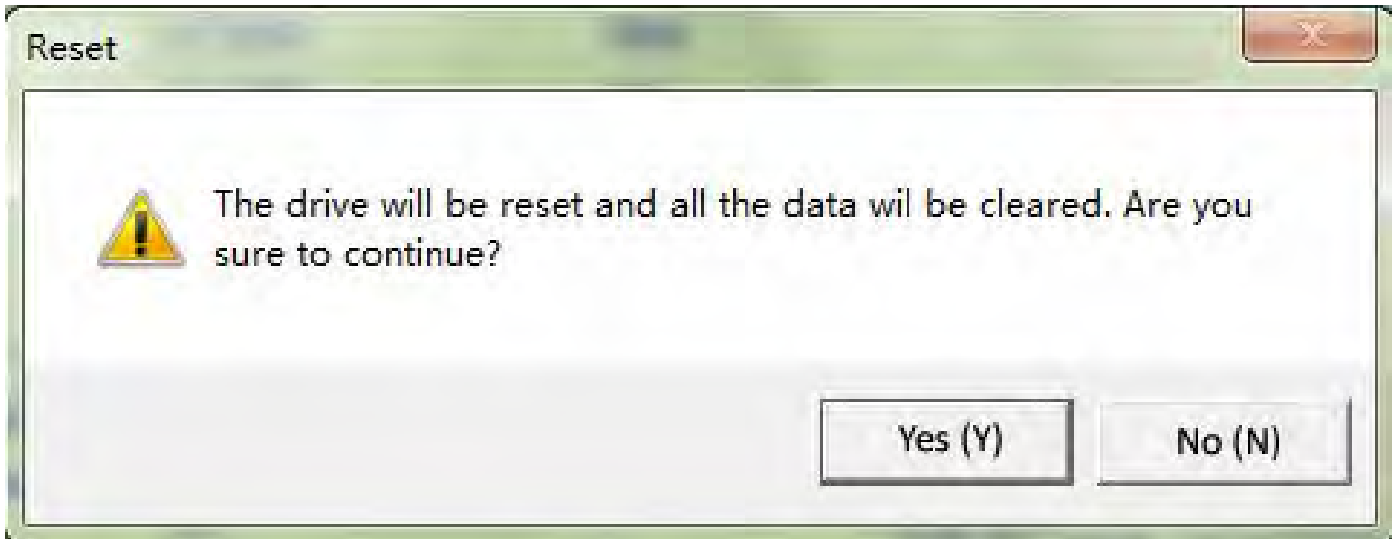

Motor Settings Window

Click **Drive->Motor Settings** to open this window. You can set the micro step resolution, position following error limit and encoder resolution in this window.

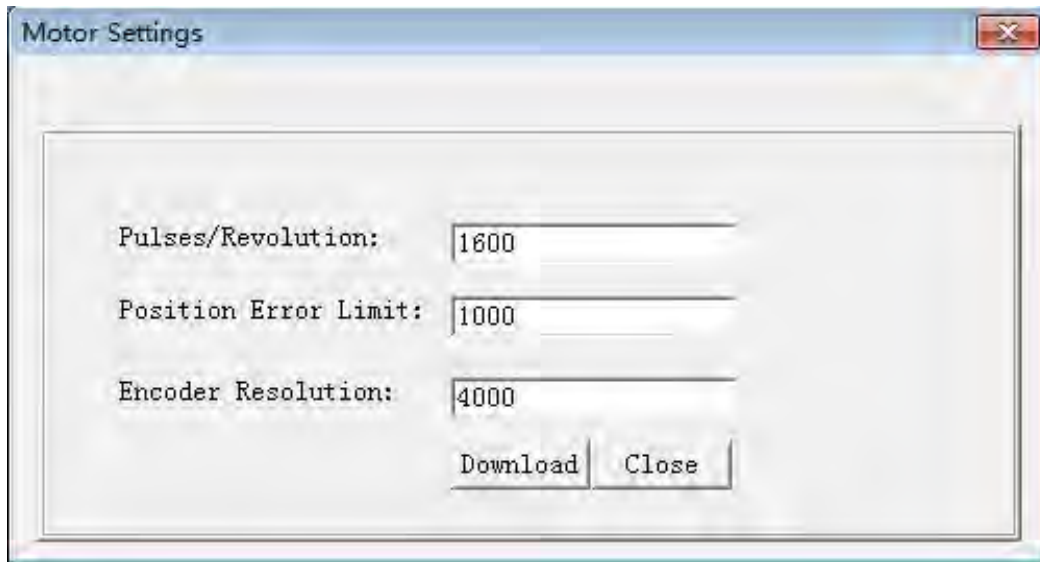

Illustration to the motor settings

Item	Description	Value
Pulse / Revolution	Drive s micro step setting for the motor. It can be set from 200-51200 by step 1.	200 - 51200
Position Error Limit	The limit of the position following error. When the actual position error exceeds this value, the drive will goes into error mode and the fault output will be activated.	0 - 65535
Encoder Resolution	Enter a value equals to 4 times of number of lines of the encoder. For example, if the encoder is a 1000-line encoder, it is 4000. Note: Do not change the default value 4000 is for Leadshine standard easy servo motors.	200-51200



Parameters Window

Click **Tools->Parameters** to open the parameter operation window.

Read Drive

Click **Read drive** button to upload all parameters from the drive. Double click the value of a parameter, you can change that value. Most of the parameters can be found in other windows of this setup software. The parameters only appears in this window are not recommended to change.

Parameter	Range	Value	Unit
Current Loop Kp	0~32766	3221	
Current Loop Ki	0~32766	357	
Pulses/Revolution	200~51200	1600	
Encoder Resolution(ppr)	200~51200	4000	
Position Error Limit(Pu...)	0~65535	1000	
Position Loop Kp	0~32767	2500	
Position Loop Ki	0~32767	500	
Position Loop Kd	0~32767	100	
Position Loop Kvff	0~32767	30	
Holding Current (%)	0~100	50	
Open-loop Current (%)	0~100	50	
Close-loop Current (%)	0~100	100	
Anti-interference Time	0~1000	1000	
Enable Control	0~1	1	0-Hight Level;1-Low Level
Fault Output	0~1	1	0-Active High Impedance...
Filtering Enable	0~1	0	0-Disenable;1-Enable
Filtering Time(us)	50~25600	25600	
Reserved parameter	0~1	0	
Pulse Active Edge	0~1	0	0-Rising;1-Falling
Pulse Input Mode	0~1	0	0-PUL/DIR;1-CW/CCW

Download

Click **Download** button to apply the changes.

Open File

If you want to load parameters from a PC file, click **Open File** button in the **Parameters Window**. The parameters in the software s workspace will be updated.

Save As

Click **Save As** button to save the parameters of current workspace to a file. This file can be used to configure other drives.



Parameters Window (Continued)

Save

Click **Save** button to write the parameters to the drive's nonvolatile memory.

Illustration to the parameters not appeared in other window

Parameters	Description	Value
Position Loop Kp	The PID parameters of the position loop. The default values are suitable for most of the application. You don't need to change them. Contact Leadshine technical support if you have any question.	0 - 32767
Position Loop Ki		
Position Loop Kd		
Position Loop Kvff		
Holding Current (%)	Motor current rate when the motor is at standstill. This parameter affects the holding torque of the motor.	0 - 100%
Open Loop Current (%)	Open loop current rate. It's suitable for most of the applications. You don't need to change the default value.	0 - 100%
Close loop Current (%)	Close-loop current rate. This parameter affects the dynamic torque of the motor.	0 - 100%



Check Errors

You can check the active error or the error log of the drive in this window.

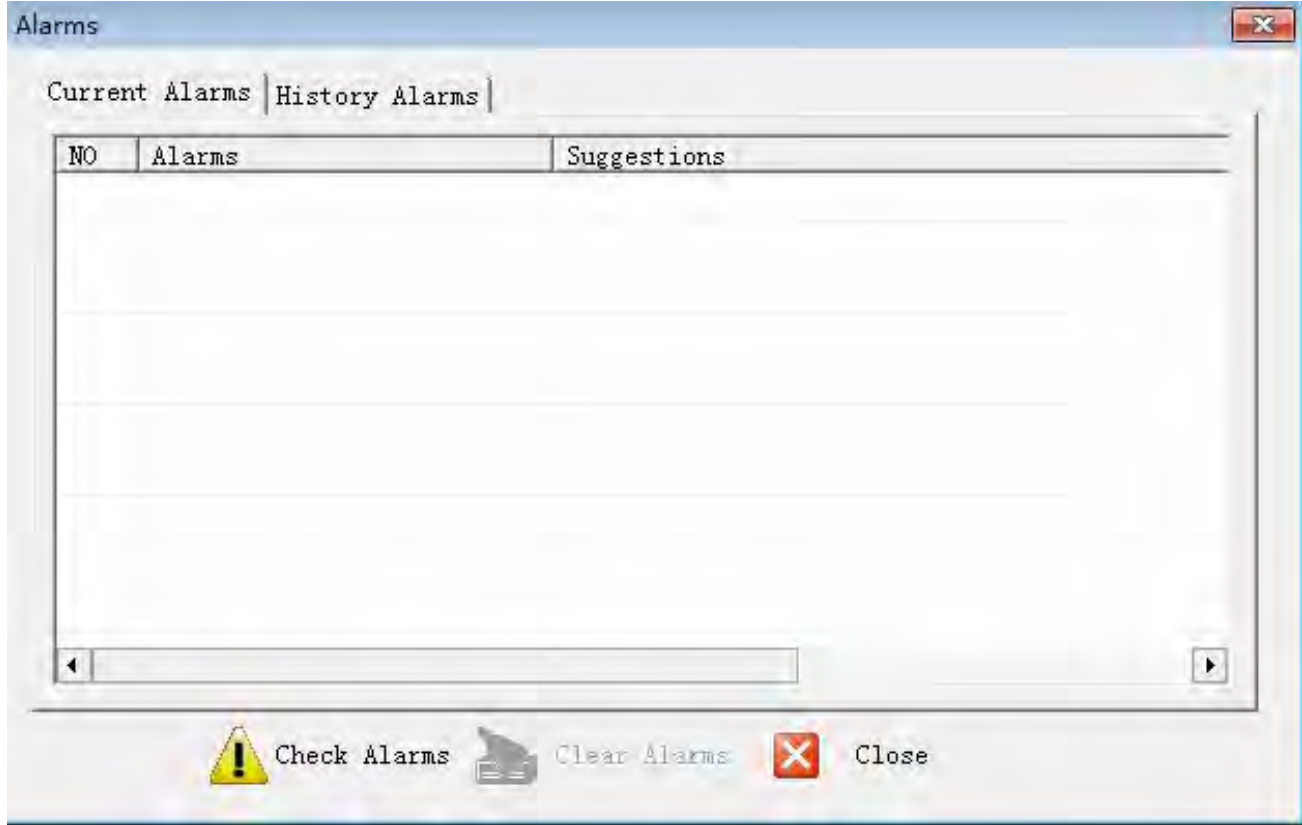

Illustration to the error type

Item	Description
Over Current Error	Error occurs when the motor coil current exceeds the drive s current limit.
Over Voltage Error	Error occurs when the input voltage exceeds the drive s voltage limit
Position Following Error	Error occurs when the actual position following error exceeds the limit which is set by the Position Error Limit .



Configuring the Drive

Typically, you can follow the steps below to configure the drive.

- Step 1:** Set Input/Output parameters such as pulse mode, active edge of pulse, active impedance of fault output, active impedance of the in-position output according to the application.
- Step 2:** Configure motor settings such as micro step resolution, the limit of the position following error.
- Step 3:** Set the holding current and close-loop current which affects the motor torque and speed.
- Step 4:** Manually tune the current loop gain Kp and Ki if necessary.
- Step 5:** Save parameters to Drive's NVM.

Step 1: Configuring Inputs/Outputs

Click **Drive->Inputs/Outputs** to open the inputs/outputs window. You can set the active edge of pulse, pulse mode, the active impedance of fault output and the active level of the enable input in this window. Refer to the **Using the Software** chapter for more information.

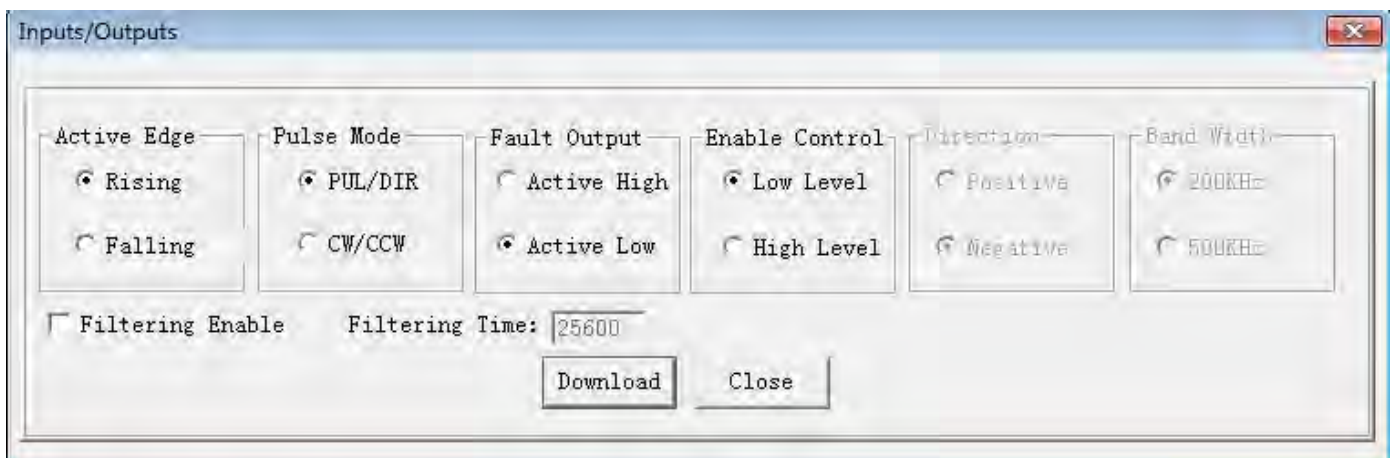

Step 2: Configuring Motor Settings

Click **Drive->Motor Settings** to open the motor setting window. You can set the micro step resolution, position error limit and check the encoder resolution in this window. Refer to the **Using the Software** chapter for more information.

The microstep resolution can be set from 200- 51200. High resolution makes the motor move more smoothly. If the application requires small position following error, reduce the **Position Error Limit**. Usually it is recommended to set it to 1000.



For encoder resolution, do not change the default value of 4000 if you are using Leadshine standard easy servo motors. See related description in page 11 for more information.



Step 2 (Continued): Configuring Motor Settings

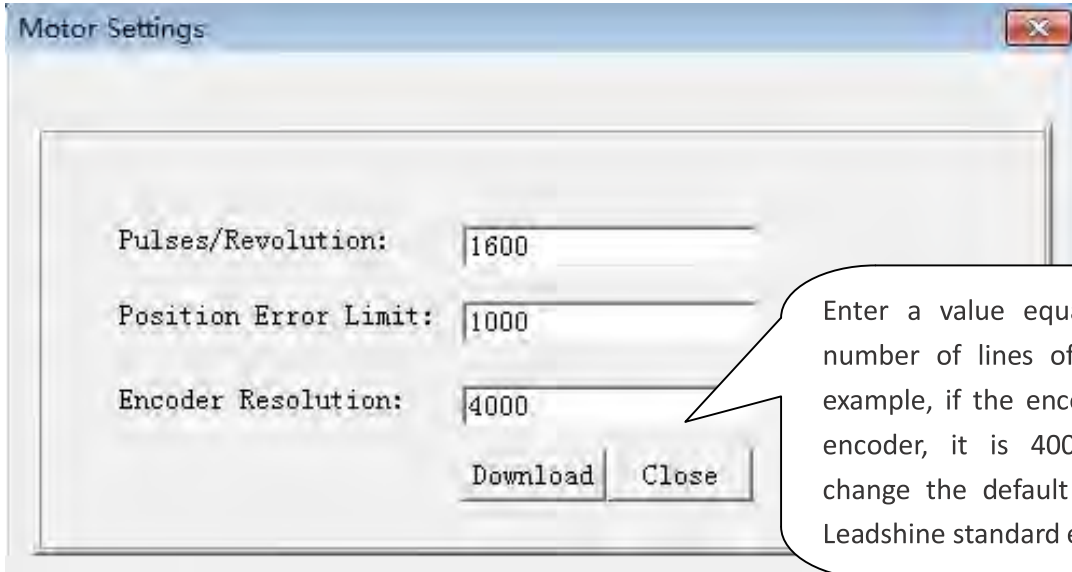

Step 3: Set Motor Current

When there is no pulse sent to the drive, the easy drive goes into idle mode. The actual motor current is determined by the holding current (similar to "idle current" of open loop stepper drives). In normal working mode, the easy drive monitors the actual shaft position all the time. The current outputted to the motor changes dynamically based on the tracking error between the actual position and the commanded position.

The actual current outputted to the motor can be calculated as follows:

$$\text{Holding Current} = 6A \times \text{Holding Current (\%)}$$

$$\text{MAX Close loop Current} = 6A \times \text{Close Loop Current (\%)}$$

Low holding current can reduce motor heating however also reduces the holding torque which is used to lock the motor shaft at standstill. It is recommended to determine the holding current by whether or not there is big vibration at start-up and how much lock torque is required, based on your actual applications.

Click the **Tools->Parameters** and the Parameters appears. Click the "Read" button to get all the parameters from the drive. Double click the value column to edit the parameter.



Step 3 (Continued): Set Motor Current

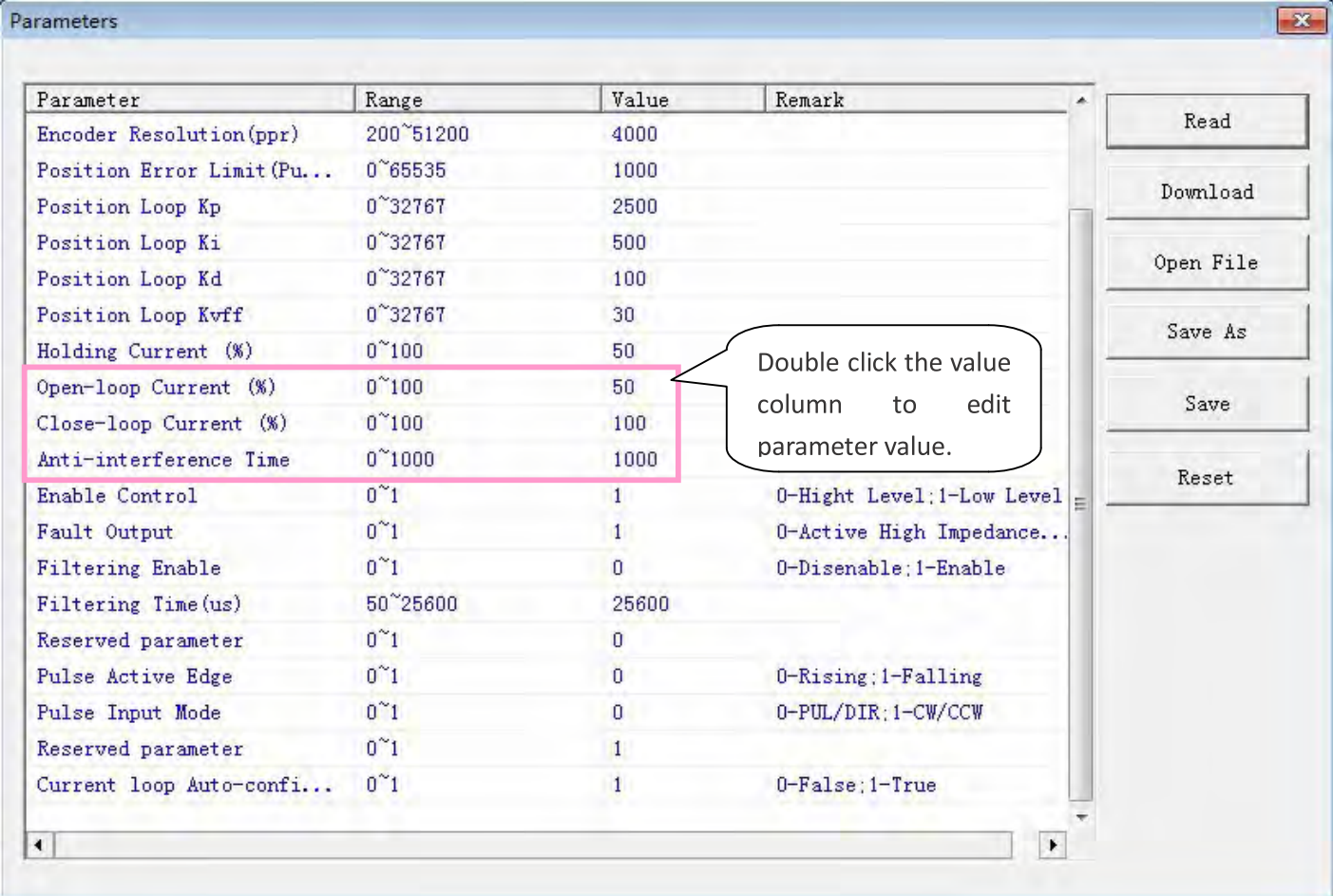

Parameter	Range	Value	Remark
Encoder Resolution(ppr)	200~51200	4000	
Position Error Limit(Pu...)	0~65535	1000	
Position Loop Kp	0~32767	2500	
Position Loop Ki	0~32767	500	
Position Loop Kd	0~32767	100	
Position Loop Kvff	0~32767	30	
Holding Current (%)	0~100	50	
Open-loop Current (%)	0~100	50	
Close-loop Current (%)	0~100	100	
Anti-interference Time	0~1000	1000	
Enable Control	0~1	1	0-Hight Level;1-Low Level
Fault Output	0~1	1	0-Active High Impedance...
Filtering Enable	0~1	0	0-Disenable;1-Enable
Filtering Time(us)	50~25600	25600	
Reserved parameter	0~1	0	
Pulse Active Edge	0~1	0	0-Rising;1-Falling
Pulse Input Mode	0~1	0	0-PUL/DIR;1-CW/CCW
Reserved parameter	0~1	1	
Current loop Auto-confi...	0~1	1	0-False;1-True

Step 4: Tune Kp and Ki of the current loop

Note: The Kp and Ki are auto-configured at power-up when the "current loop auto-configuration" check box is selected in the current loop window. There is no need to tune them and you can ignore the following steps.

Click the **Drive-> Current Loop / Motion Test** start the tuning. In the open window, the default tab is Motion Test. If you want to tune the current loop Kp and Ki manually, first uncheck the "current loop auto-configuration" and don't forget to save the change to the drive's EEPROM by clicking the "Save" button in the "Parameter" window. Click the **Current Loop** tab and then tune current loop Kp and Ki.



Step 4(Continued): Tune Kp and Ki of the current loop

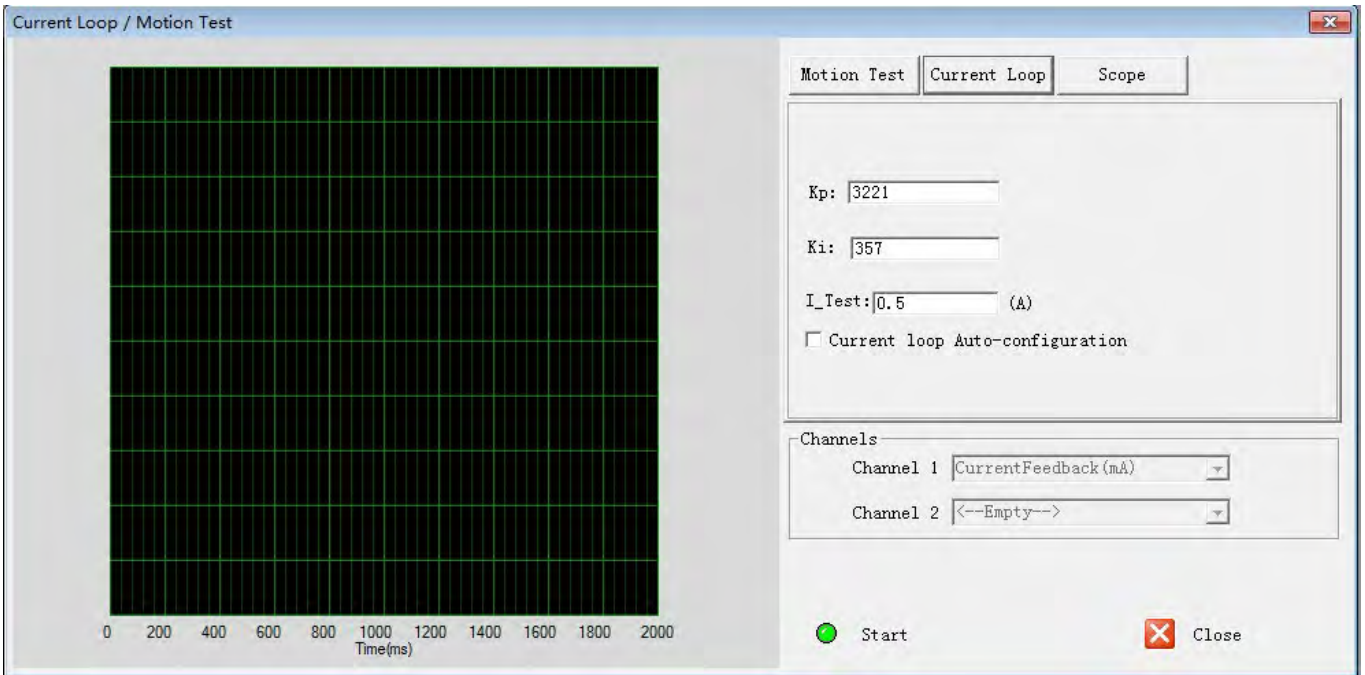

Below is an tuning example based on the ES-D808 and ES-M23440 with 36VDC power supply.

1: Set **I_Test** to 1 and start the tuning with small **Kp** and zero" **Ki**. Here we set **Kp=500** and **Ki=1**. **I-Test** is the amplitude of the target. Here we set it to 1Amp. I-Test is usually 15%-70% of the motor s rated current.

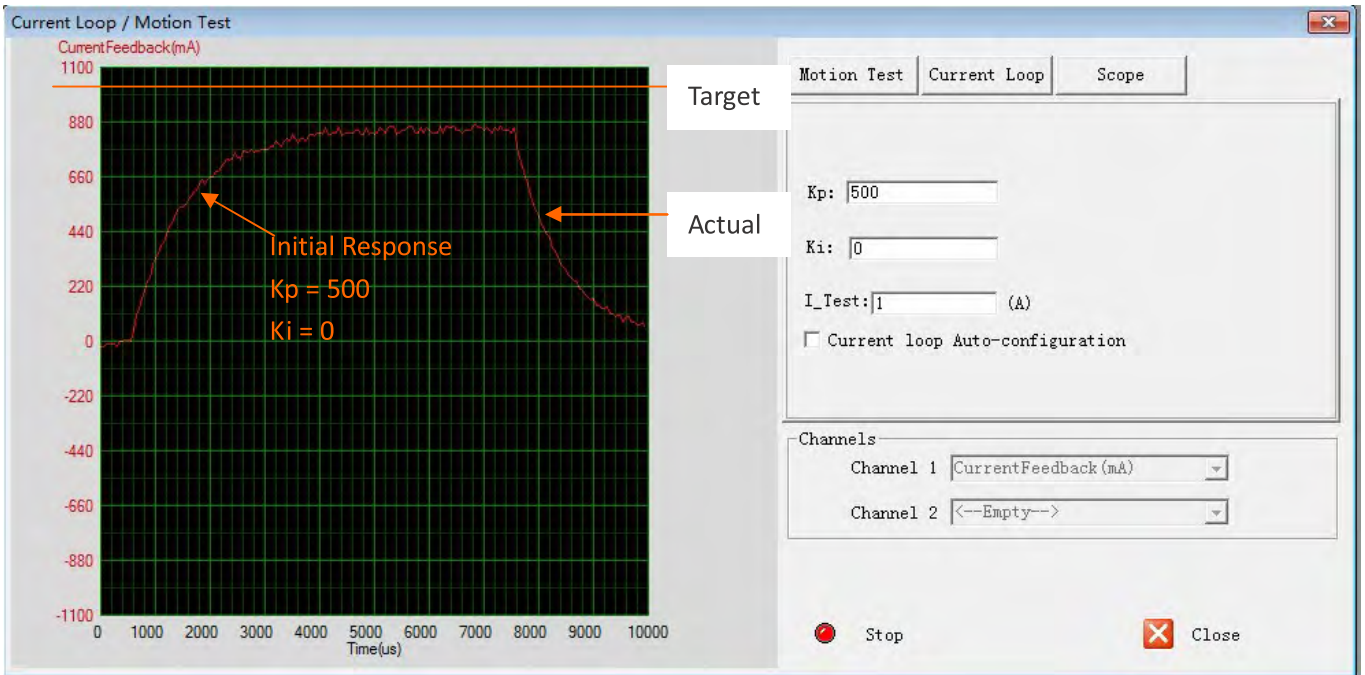

2: Click the **Start** button and the plot window shows the step response of the current test. As the red curve increases from 0 to target slowly, it indicates that a large **Kp** needs to be introduced.



Step 4 (Continued): Tune Kp and Ki of the current loop

3: Increase **Kp** to 1000 and click **Start**. The red curve change faster from 0 to the target.

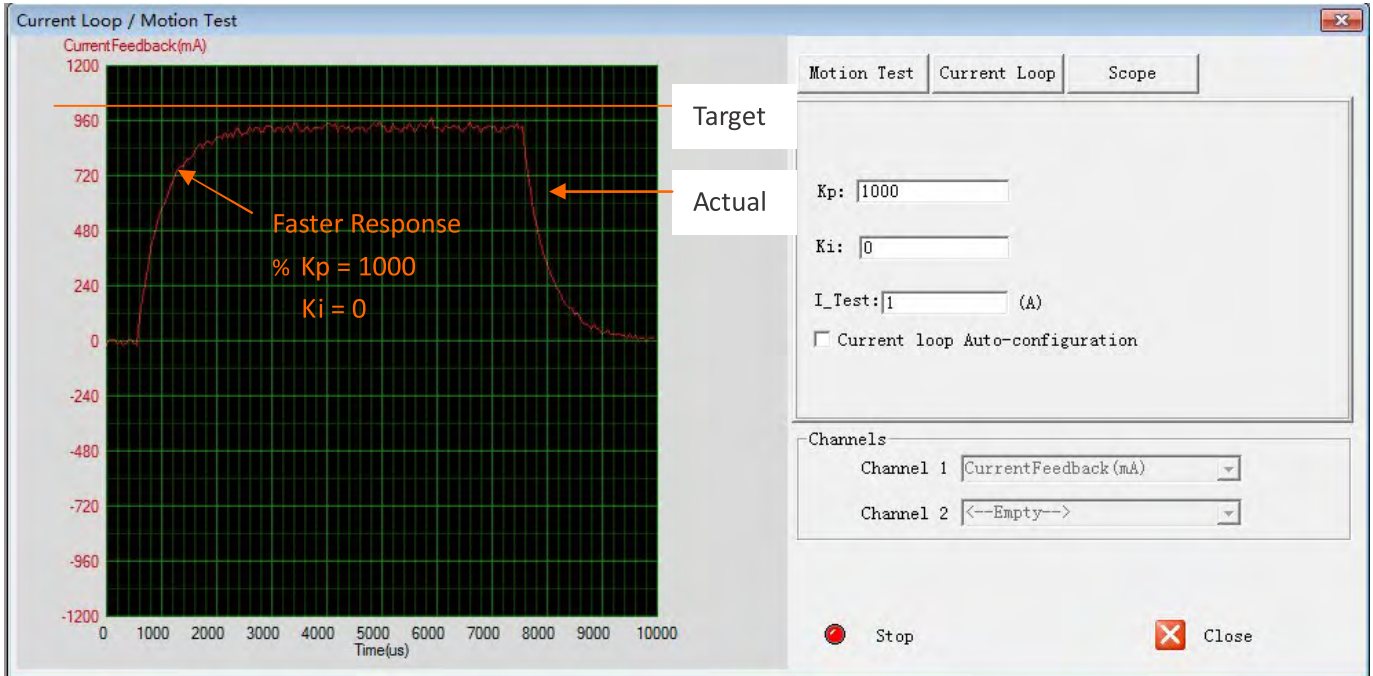

4: Set **Kp** to 2000, 3000 and 5000, respectively. Then click **Start**. The red curve is changing faster and faster. However over-shoot appears when **Kp** is 5000. It indicates that you need to stop increasing Kp and back off. So we decrease Kp to 4000 until the actual value is exactly over the target value.

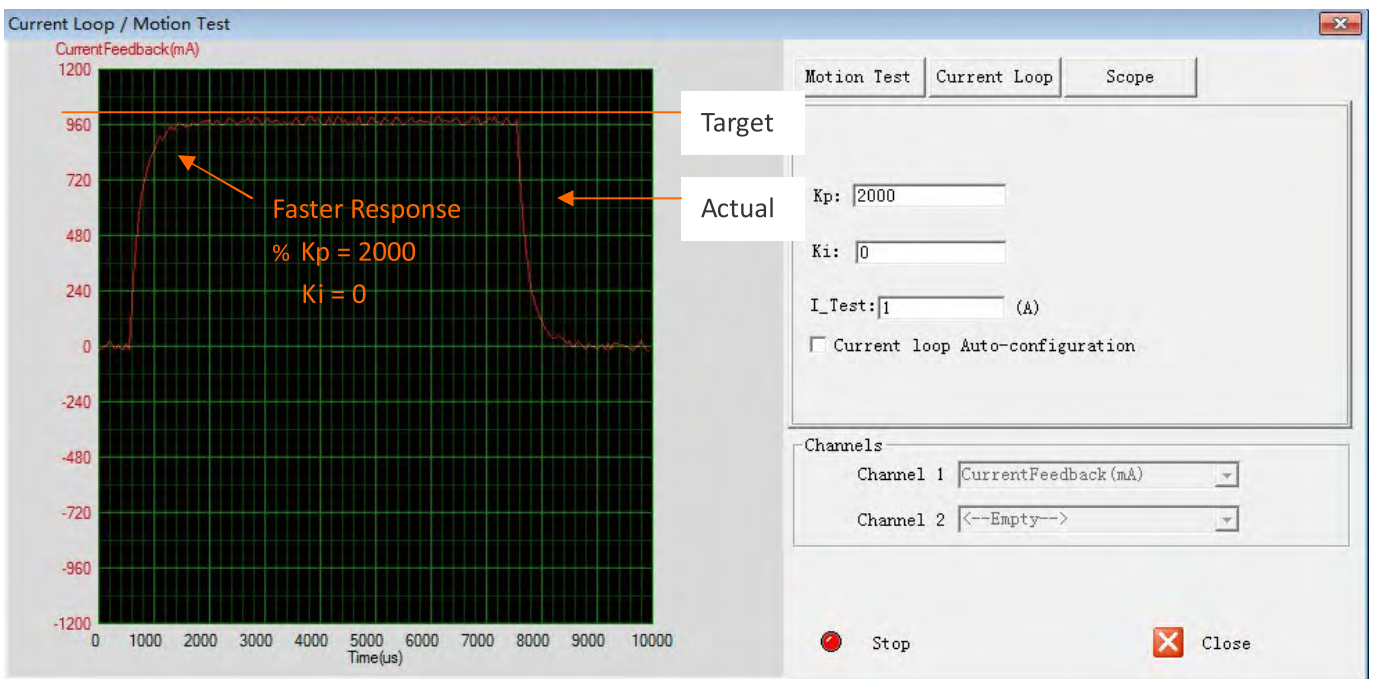

Step 4 (Continued): Tune Kp and Ki of the current loop

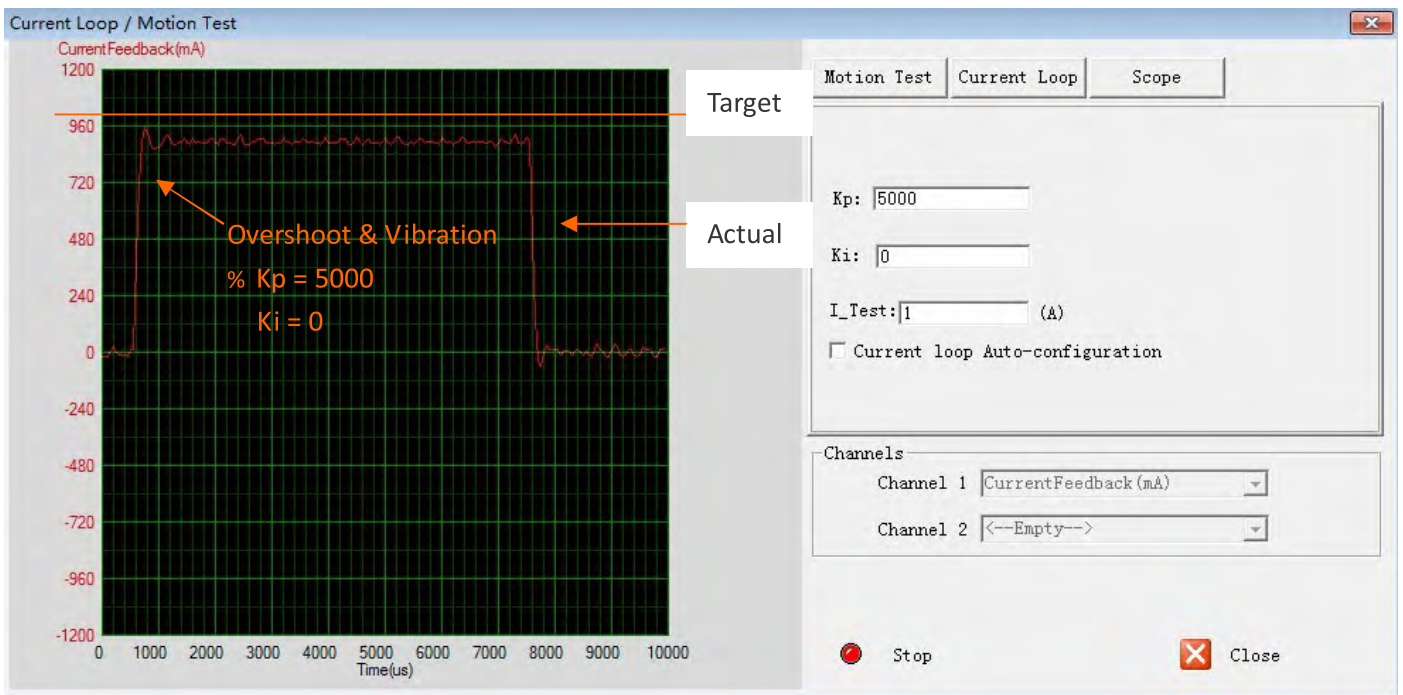
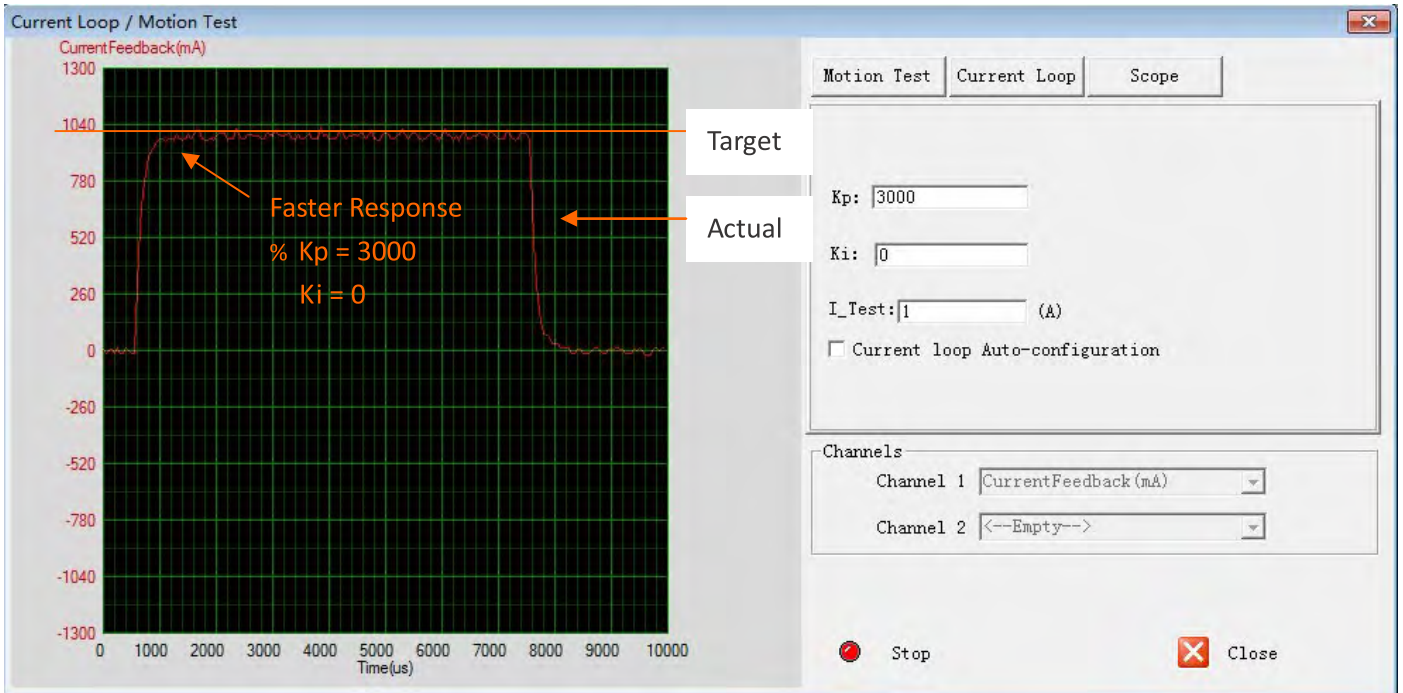

Step 4 (Continued): Tune Kp and Ki of the current loop

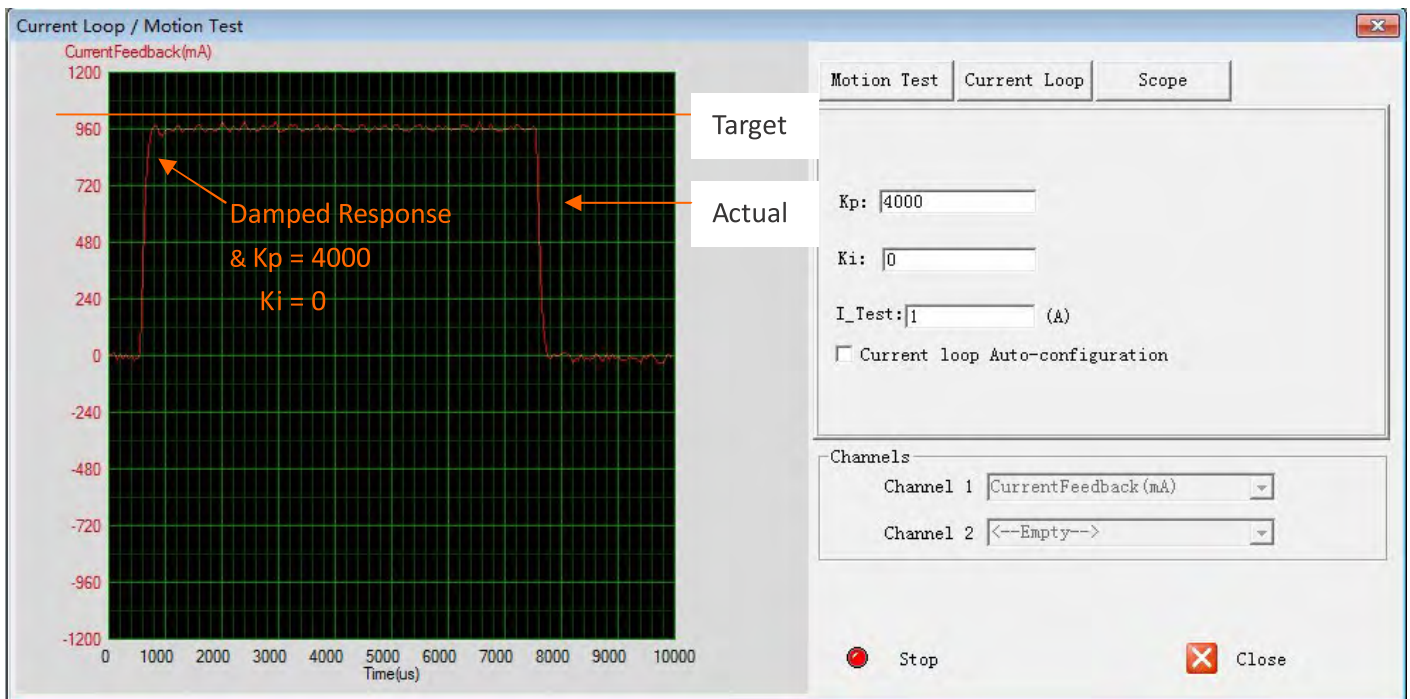

5: Now the K_p is relatively good enough. But there is still error between the actual current and the target current. So we need to introduce K_i to reduce the steady error of the constant part. It follows the same procedure as K_p . High K_i causes big vibration, system lag and makes the performance worse. The following figures show how to tune the integral gain.

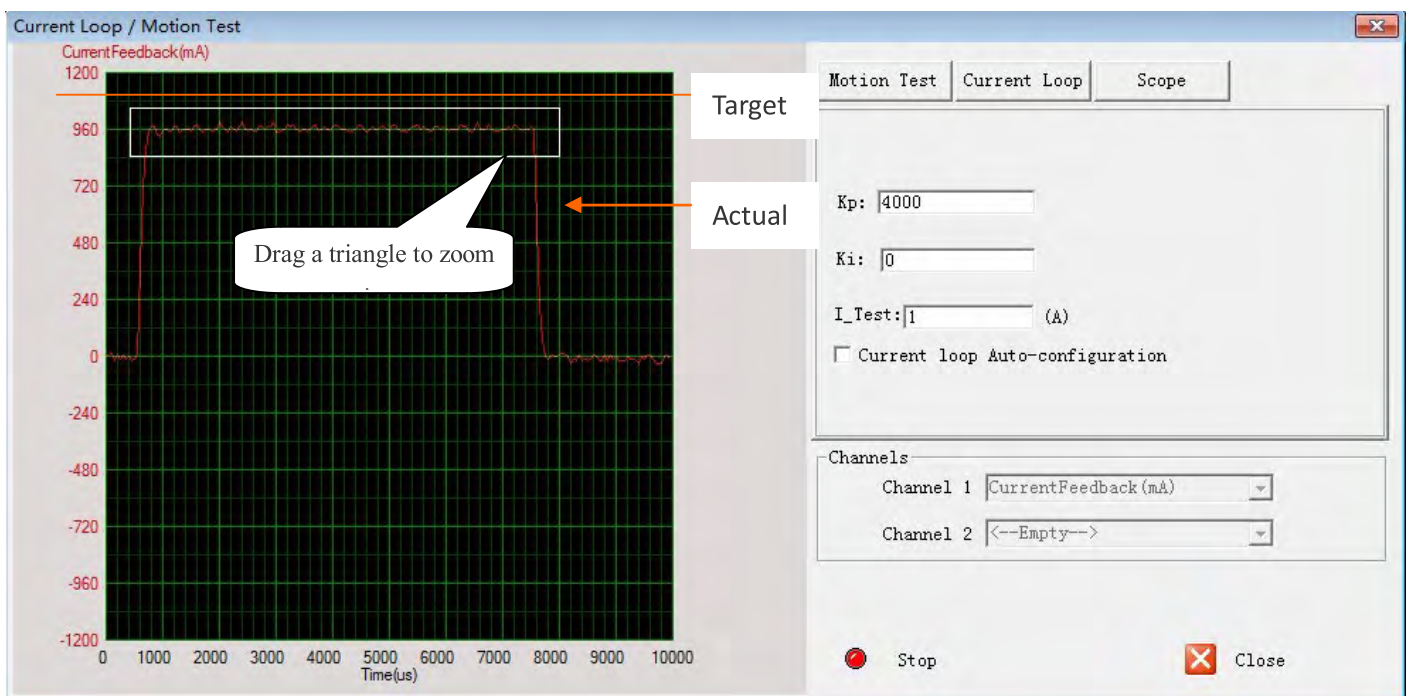

Step 4 (Continued): Tune Kp and Ki of the current loop

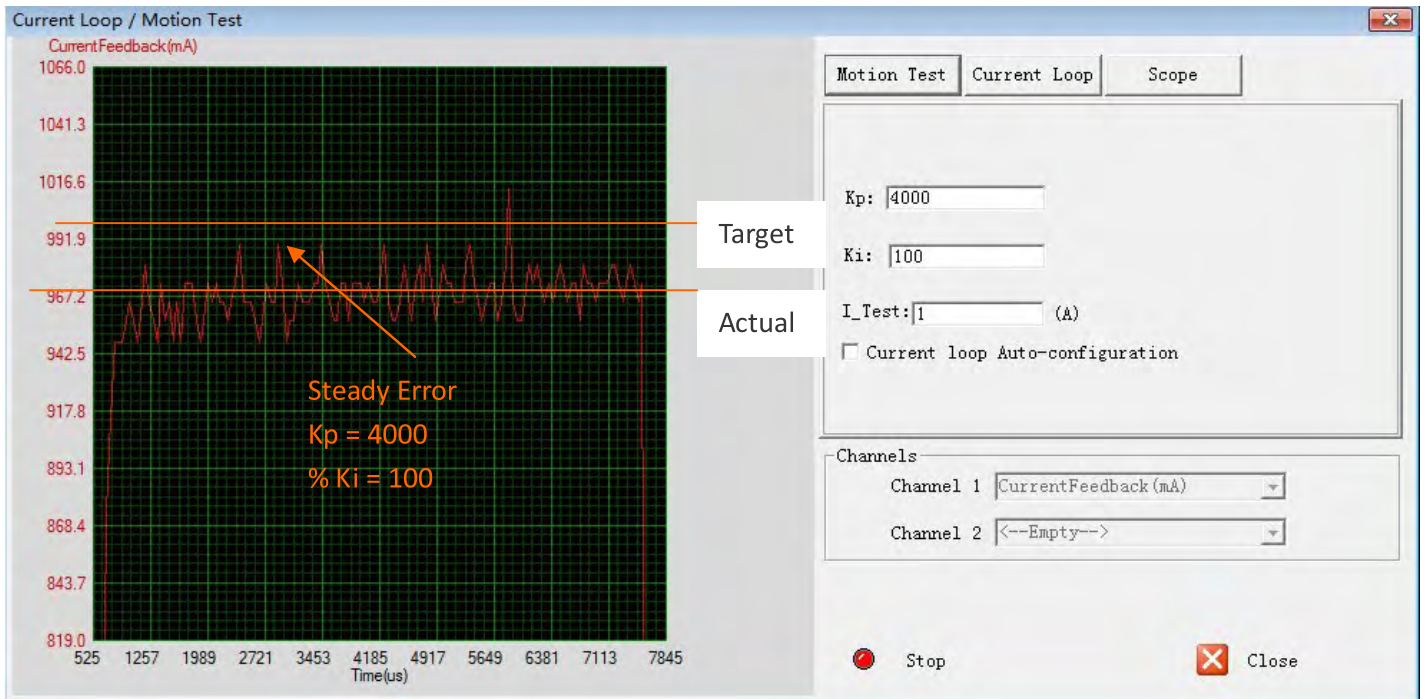
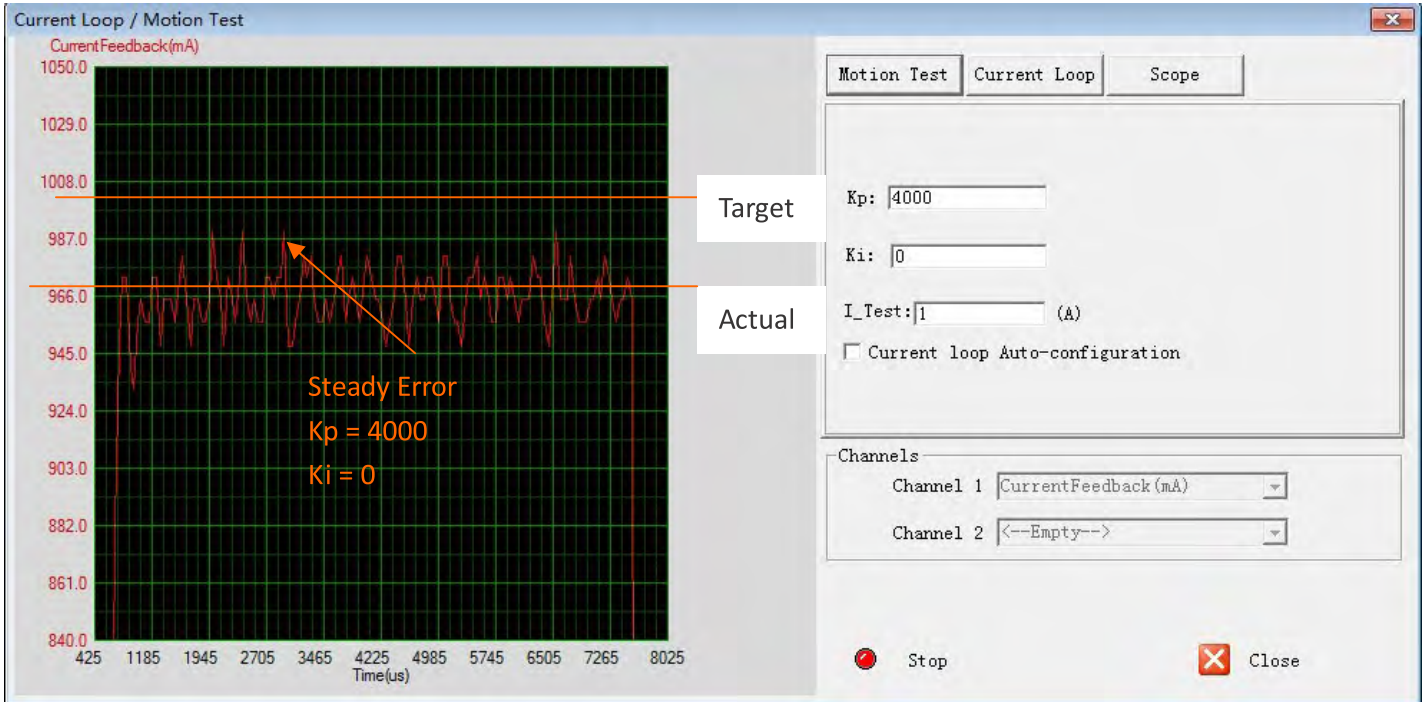

Step 4 (Continued): Tune Kp and Ki of the current loop

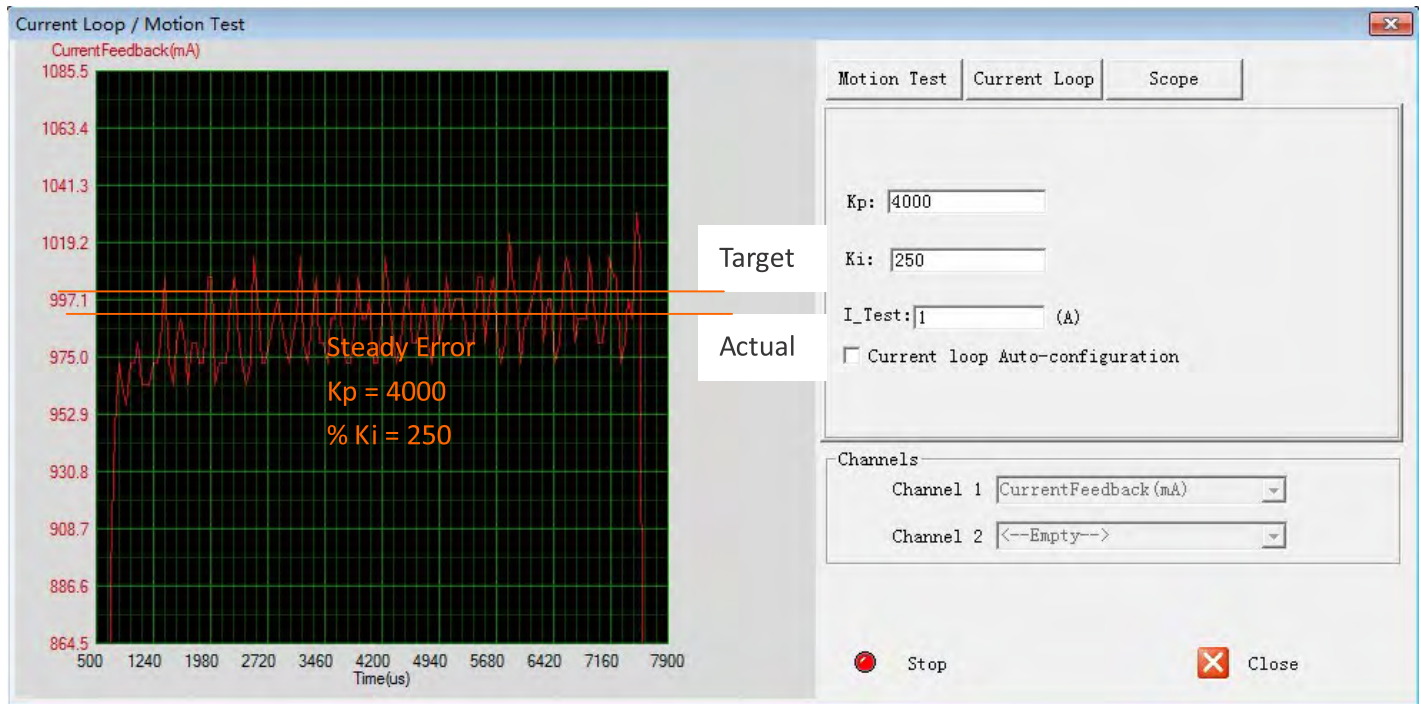

Step 5: Save parameters to drive s NVM

All the parameters are just stored in the driver s RAM. They will be lost when we power off the driver. Don t forget to click the **Save Drive Parameters** icon to store the changed value to the drive s EEPROM. See below.



Save all the changes to the drive s nonvolatile memory.



More about the Position Loop Parameters



Leadshine already loads default current-loop parameters and position-loop parameters. Those default parameter values have been optimized. They should be good enough for most industrial applications, and there is no need to tune them. However, if you want to tune them for best performance for your applications, ProTuner allows you to adjust those parameters



The effect of K_p , K_d , K_i and K_vff is similar as the items in servo control system. But they are not completely the same. The adjustable range of K_p , K_d , K_i and K_vff is from 0-32767. However, do not give too low or high value to these parameters. It is recommended to adjust them by 10%-30%. Otherwise the drive's performance may go bad!

To adjust the position loop parameter, click **Tools->Drive Parameters** to view the parameters. The position loop parameters appear and you can adjust them by the steps as follows:

- 1) Select the row.
- 2) Double click the cell value in Value column. The number will be selected and you can change it.
- 3) Click other place to confirm the input.

Parameter	Range	Value	Remark
Encoder Resolution(ppr)	200~51200	4000	
Position Error Limit(Pu...)	0~65535	1000	
Position Loop K_p	0~32767	2500	
Position Loop K_i	0~32767	500	
Position Loop K_d	0~32767	100	
Position Loop K_vff	0~32767	30	
Holding Current (%)	0~100	50	
Open-loop Current (%)	0~100	50	
Close-loop Current (%)	0~100	100	

Tuning Tips

Faster Response, High Speed, High Torque, Smooth Move

Increase the K_p , K_d , K_vff , Open-Loop Current and Close-loop Current.

Lower Motor Noise, Lower Motor Heating

Decrease the K_p , K_d , K_vff , Open-Loop Current and Close-loop Current

