

Datasheet of the High Voltage Easy Servo Drive *ES-DH1208*



70-130VAC, 8.0A Peak, Closed-loop, No Tuning



Features

- Hybrid servo control technology to combine advantages of open-loop stepper systems and brushless servo systems
- Closed-loop controls to eliminate lose of steps, stall or movement synchronization
- High starting torque and quick response
- Smooth motor movement with no vibration
- Excellent respond time, quick acceleration, and very high high-speed torque (30% over open-loop)
- Load-dependent dynamic current output from drive to motor to significantly motor heating deduction
- Input voltage from 70 to 130 VAC; MAX 8.0A peak current output from drive to motor
- Micro step resolution value from 200-51,200 (increased by 1) via software configuration
- Isolated control inputs of Pulse, Direction and Enable
- No tuning for plug and play setup
- On-board HMI for easy setup and configuration
- In-position and fault outputs to external motion controllers for complete system controls.
- Over voltage, over-current, and position-error protection
- Servo control for stepper motors with encoders up to NEMA 42

Description

By taking direct 110 / 120 or 220 / 230 VAC input, Leadshine ES-DH series high voltage easy servo drives can power large NEMA 34 and 42 easy servo motors and offer huge torque to applications with motion control systems.

Leadshine ES-DH series easy servo drives are based on the latest DSP technology and Leadshine's advanced control algorithm of combing brushless servo and stepper systems. They are featured with closed position loop, offering huge torque, excellent acceleration & quick response, no torque reservation, high standstill stiffness, extra low noise & heating, smooth motor movement, no hunting, no overshooting for almost zero settling time, and no tuning for almost all applications.

Applications

Due to combining the features of both brushless servo drives and stepper drives, Leadshine ES-DH series easy servo drives are suitable for both upgrading conventional stepper systems, and replacing brushless servo systems which have closed loop and high torque requirements.

Leadshine ES-DH series easy servo drives can also be implemented as high performance open loop stepper drives with direct 110 / 120 and / or 220 /230 VAC input.

Leadshine ES-DH easy servo drives and matching easy servo motors have been successfully implemented by many OEM clients in applications such as CNC routers, plasma, milling machines, engravers, packaging machines, printing equipments.



Specifications

Electrical Specifications

Parameters	ES-DH1208
Operating Voltage	70 - 130 VAC
Maximum Continuous Current	8.0 A
MAX Step Frequency	200KHz or 500KHz (Software Configuration)
Step, Direction and Enable Voltage	5 24 V
Logic Signal Input Current	7 20 mA

Control Specifications

Parameters	ES-DH1208
Command Input	Step/Direction, CW/CCW
Enable/Disable Input	Differential
Alarm Signal Output	Isolated OC Output
Configuration Interface	On-board HMI or RS232 communication
Regeneration Resistor	No

Mechanical Specifications

Parameters	ES-DH1208
Size	180mm * 140mm* 70mm
Weight	1500 g

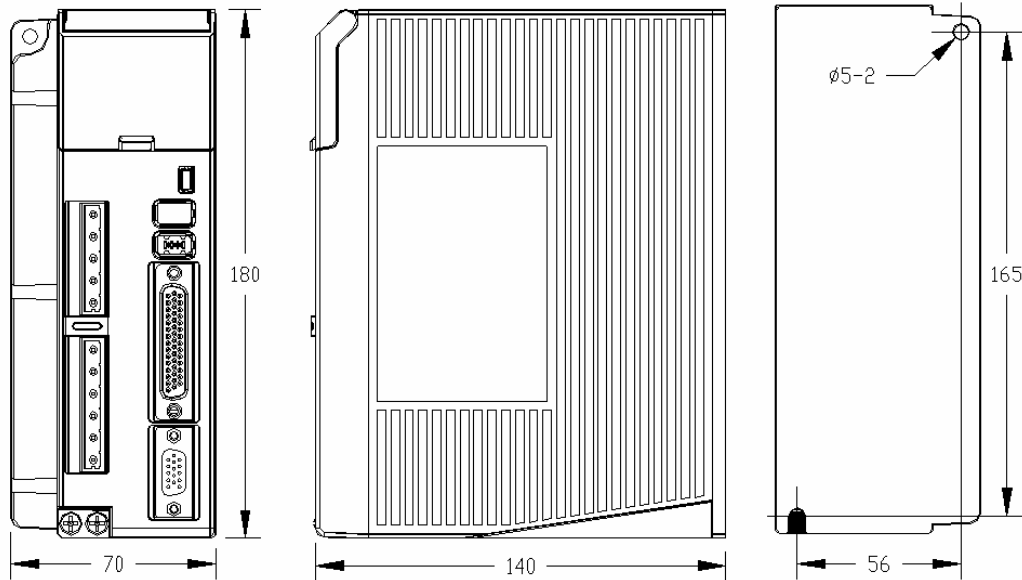

Operating Environment

Cooling	Natural cooling or Forced cooling
Ambient Temperature	0 – 40 °C
Humidity	40% RH to 90% RH, No Condensation
Vibration	5.9 m/s ² MAX
Storage Temperature	-20 °C to 80 °C

Drive Appearance and Interfaces

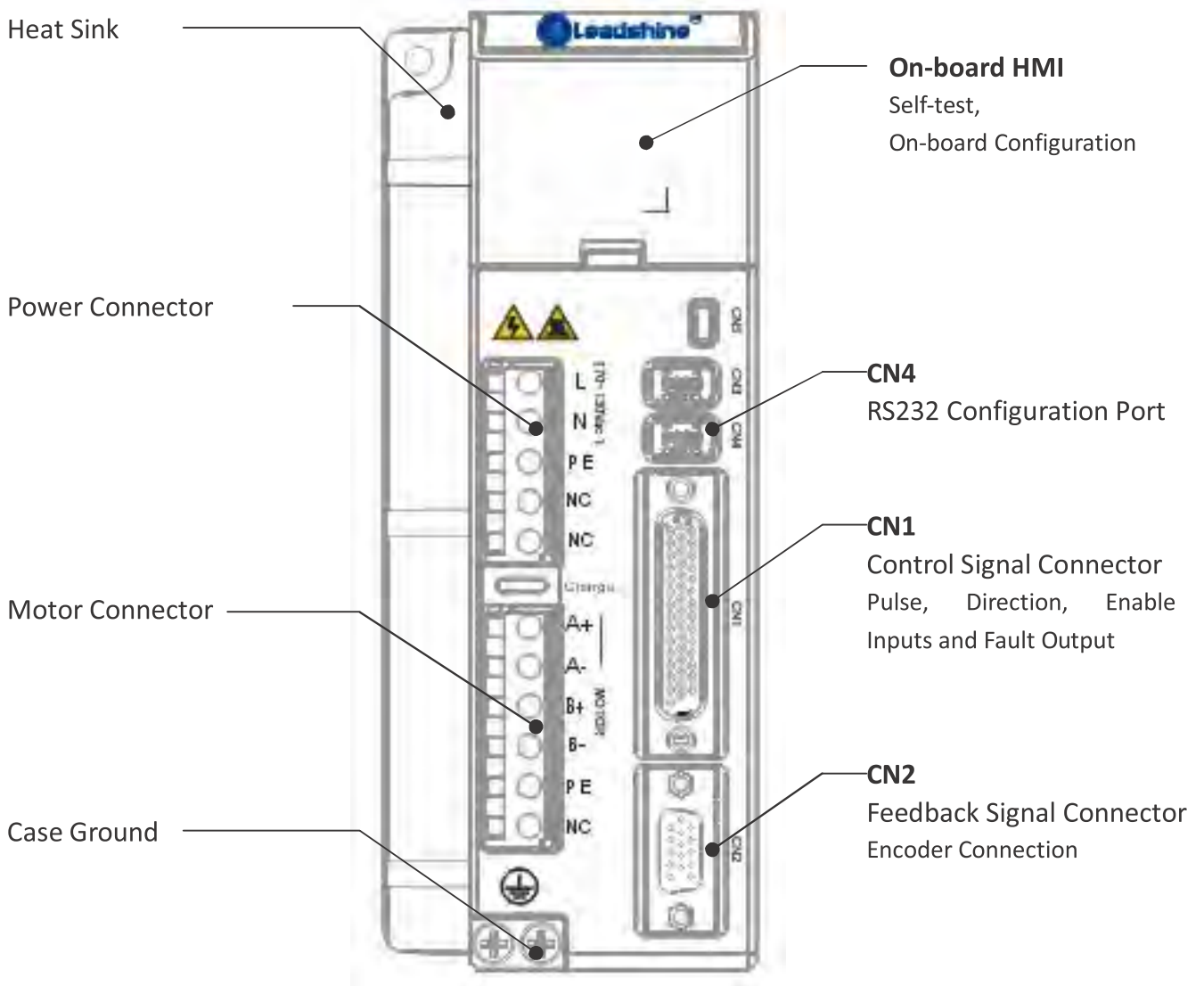

Connectors and Pin Assignments

CN1 – Control Signal Connector			
D-Sub, 26 Pin, Female			
Pin	Name	I/O	Description
1	NC	-	No connection.
2	NC	-	No Connection.
3	PUL+	I	Pulse signal: In single pulse (pulse/direction) mode, this input represents pulse signal, each rising or falling edge active (software configurable); In double pulse mode (software configurable), this input represents clockwise (CW) pulse, active both at high level and low level. 5-24V when PUL-HIGH, 0-0.5V when PUL-LOW. For reliable response, pulse width should be longer than 2.5uS(200K bandwidth) or 1uS(500K bandwidth)
4	PUL-	I	
5	DIR+	I	Direction Signal: In single-pulse mode, this signal has low/high voltage levels, representing two directions of motor rotation. In double-pulse mode (software configurable), this signal is counter-clock (CCW) pulse, active both at high level and low level. For reliable motion response, DIR signal should be ahead of PUL signal by 5" s at least. 5-24V when DIR-HIGH, 0-0.5V when DIR-LOW. The direction signal's polarity is software configurable.
6	DIR-	I	
7	ALM+	O	Alarm Signal: OC (Open Collector) output signal, activated when one of the following protection is activated: over-voltage, over current, braking error and position following error. They can sink or source MAX 100mA current at 5V. The active impedance of alarm signal is software configurable.
8	ALM-	O	
9	NC	-	No connection.
10	NC	-	No connection.
11	ENA+	O	Enable Signal: This signal is used for enabling/disabling the driver. By default, high level (NPN control signal) for enabling the driver and low level for disabling the driver. It is usually left UNCONNECTED (ENABLED). Please note that the PNP and Differential control signals are on the contrary, namely Low level for enabling. The active level of ENA signal is software configurable.
12	ENA-	O	
13	NC	-	No connection.
14	NC	-	No connection.
15	NC	-	No connection.
16	NC	-	No connection.
17	NC	-	No connection.
18	NC	-	No connection.
20	NC	-	No connection.
21	NC	-	No connection.
22	NC	-	No connection.



Connectors and Pin Assignments (Continued)

CN1 – Control Signal Connector			
D-Sub, 26 Pin, Female			
Pin	Name	I/O	Description
23	NC	-	No connection.
24	NC	-	No connection.
25	NC	-	No connection.
26	NC	-	No connection.
27	NC	-	No connection.
28	NC	-	No connection.
29	NC	-	No connection.
30	NC	-	No connection.
31	NC	-	No connection.
32	NC	-	No connection.
33	NC	-	No connection.
34	NC	-	No connection.
35	NC	-	No connection.
36	NC	-	No connection.
37	NC	-	No connection.
38	NC	-	No Connection.
39	NC	-	No connection.
40	NC	-	No connection.
41	NC	-	No connection.
42	NC	-	No connection.
43	NC	-	No connection.
44	NC	-	No connection.
	FG	-	Ground Terminal for shield



Connectors and Pin Assignments (Continued)

CN2 – Feedback Signal (Encoder) Connector

HDD15, 15Pin, Female

Pin	Name	I/O	Description
1	EA+	I	Encoder A+ input
2	EB+	I	Encoder B+ input
3	EGND	I/O	+5V output return ground
4	NC	I	No Connection.
5	NC	I	No Connection.
6	FG	I	Ground terminal for shield
7	NC	I	No Connection
8	NC	I	No Connection
9	NC	I	No Connection.
10	NC	I	No Connection.
11	EA-	I	Encoder A- input
12	EB-	I	Encoder B- input
13	+5V	O	+5V power output for encoder, MAX 100mA.
14	NC	I	No Connection.
15	NC	I	No Connection.

CN4 – RS232 Communication Connector

RS232

Can be connected to PC for drive configuration or servo tuning. Recommended twisted shielded cable and cable length < 2 meter.

Pin	Name	I/O	Description
1	GND	GND	Ground.
2	TxD	O	RS232 transmit.
3	+5V	O	Reserved +5V power output (Note: Do not connect it to RS232 port)
4	RxD	O	RS232 receive.
5	NC	-	NC
6	NC	-	NC



Connectors and Pin Assignments (Continued)

Power Connector:			
Pin	Name	I/O	Description
1	L	I	Power supply input connected to 70- 130VAC.
2	N	I	
3	PE	-	Case ground
4	NC	-	No connection.
5	NC	-	No connection.

Motor Connector			
Pin	Name	I/O	Description
1	A+	O	Motor phase A+
2	A-	O	Motor phase A-
3	B+	O	Motor phase B+
4	B-	-	Motor phase B-
5	PE	-	Case ground
6	NC	-	No connection



Connector Pin-Out

CN1 – Control Signal Connector

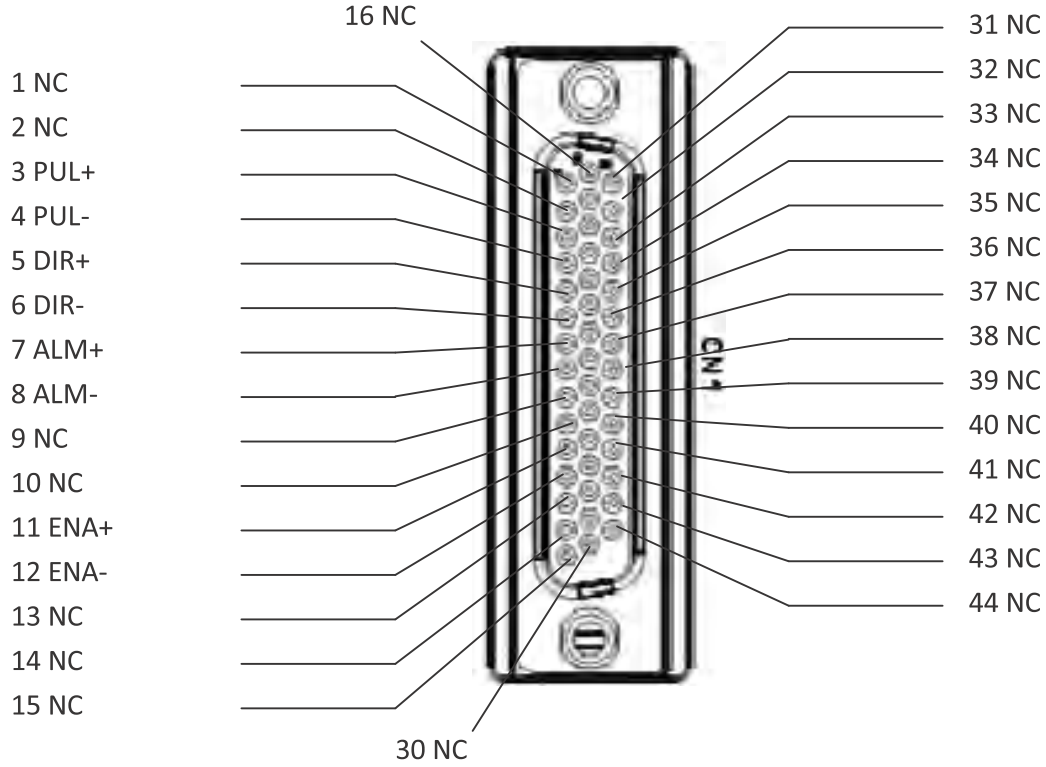

CN2 – Feedback Signal Connector

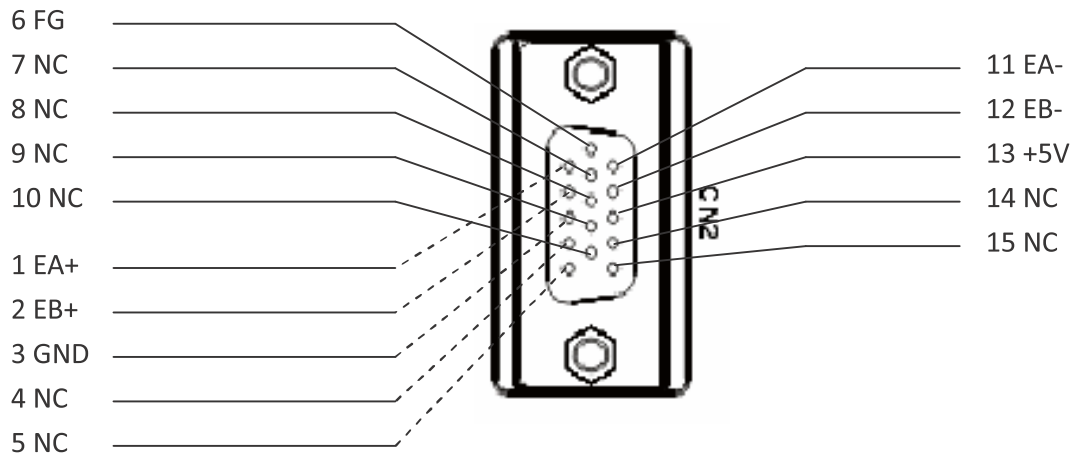

Connector Pin-Out (Continued)

CN4 – RS232 & RS485 Connector

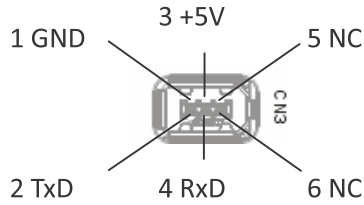

CN5 – Power Connector



CN6 ! Motor Connector

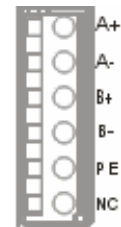

Easy Servo Motors

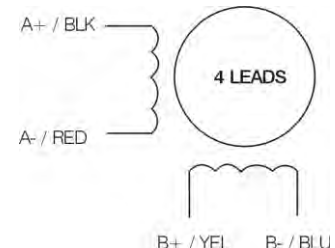
	ES-MH23480	ES-MH234120	Wiring Diagram
Step Angle (°)	1.8	1.8	 <p>Wiring diagram showing a 4-lead servo motor with the following connections:</p> <ul style="list-style-type: none"> A+ / BLK A- / RED B+ / YEL B- / BLU
Holding Torque (N.m)	8.0	12.0	
Phase Current (A)	5.0	5.5	
Phase Resistance (Ohm)	-	-	
Phase Inductance (mH)	-	-	
Shaft Inertia (g.cm ²)	-	-	
Weight (Kg)	4.0	5.6	
Encoder (lines / Rev.)	1000	1000	

Motor Encoder Cable Pin-Out

ES-MH23480, ES-MH234120

Pin	Name	Wire Color	I/O	Description
1	EA+	Black	O	Channel A+ output
2	VCC	Red	I	+5V power input
3	GND	White	GND	Ground
11	EB+	Yellow	O	Channel B+ output
12	EB-	Green	O	Channel B- output
13	EA-	Blue	O	Channel A- output

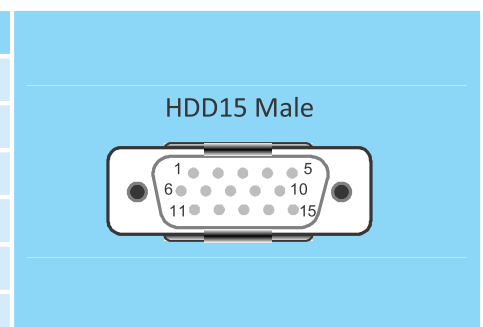

Motor Encoder Extension Cable

CABLEG-BMXMX

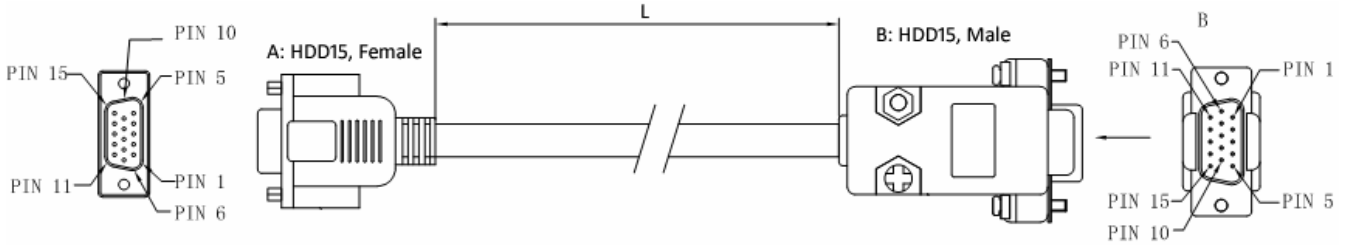

Pin Assignments

A: HDD15 Female	Wire Color	B: HDD15 Male	Name	Description
Pin		Pin		
1	Black	1	EA+	Channel A+
2	Red	13	VCC	+5V power input
3	White	3	GND	+5V GND
11	Yellow	2	EB+	Channel B+
12	Green	12	EB-	Channel B-
13	Blue	11	EA-	Channel A-

Cable Length

Part Number	L	Matching Motor
CABLEG-BM3M0	3.0m	ES-MH23480, ES-MH234120
CABLEG-BM8M0	8.0m	
CABLEG-BM10M0	10.0m	
CABLEG-BM12M0	12.0m	

Note: The encoder extension cable must be connected between the ES-MH2 motor and the ES-DH1208. You can not connect the motor s encoder cable to the ES-DH1208 directly.

Motor Power Extension Cable

CABLEH-RZXMX

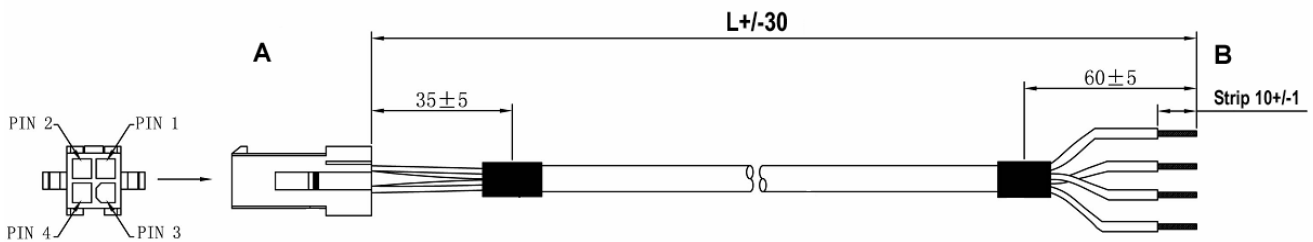

Motor Power Extension Cable (Continued)

Pin Assignments

A	B	Name	Description
Pin	Wire Color		
1	Blue	B-	Motor Phase B-
2	Red	A-	Motor Phase A-
3	Black	A+	Motor Phase A+
4	Yellow / Green	B+	Motor Phase B+

Cable Length

Part Number	L	Matching Motor
CABLEH-RZ3M0	3.0m	ES-MH23480, ES-MH234120
CABLEH-RZ5M0	5.0m	
CABLEH-RZ10M0	10.0m	

Typical Connections

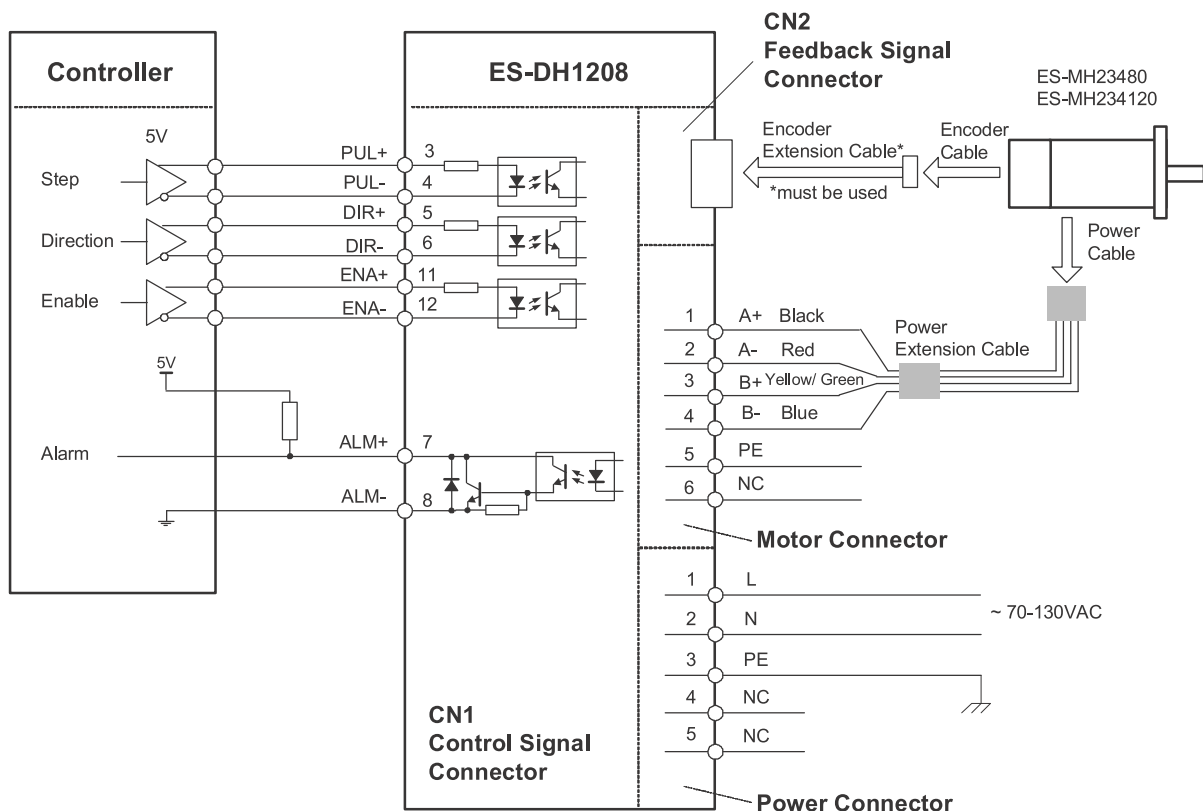

Connections to controller of differential output



Typical Connections (Continued)

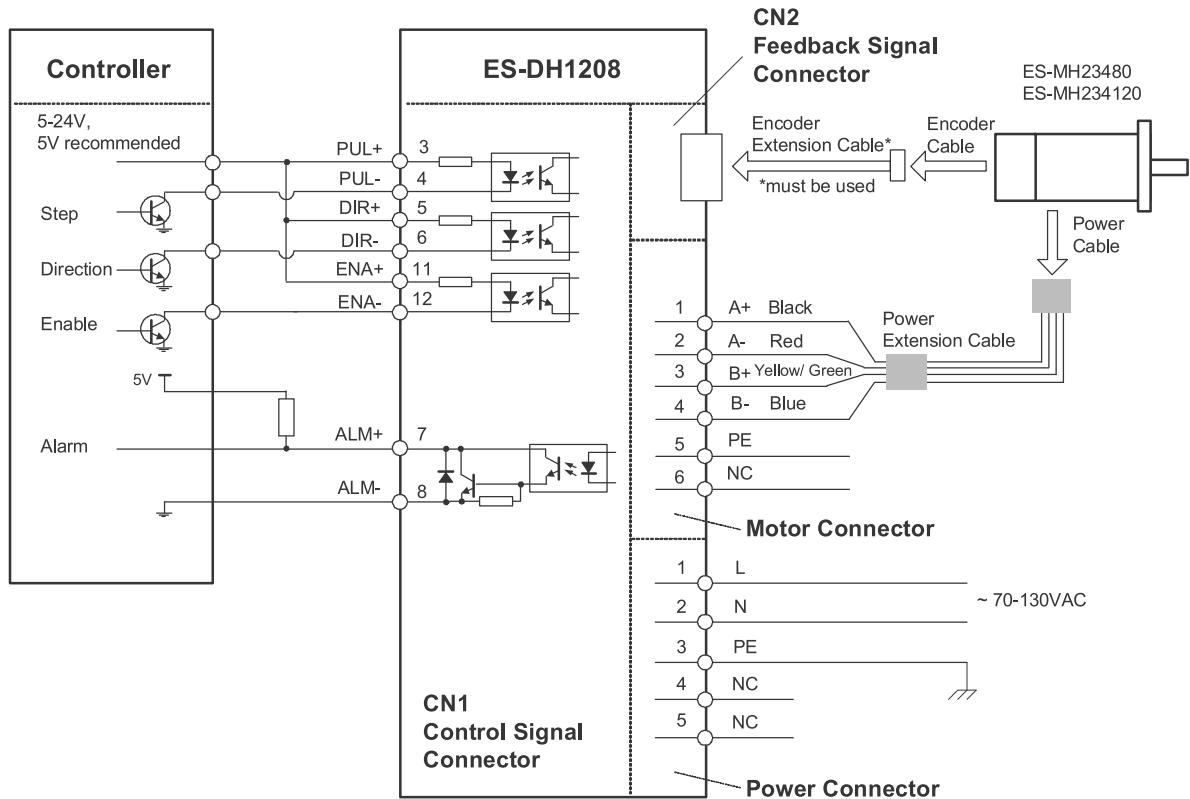

Connection to controller of sinking output

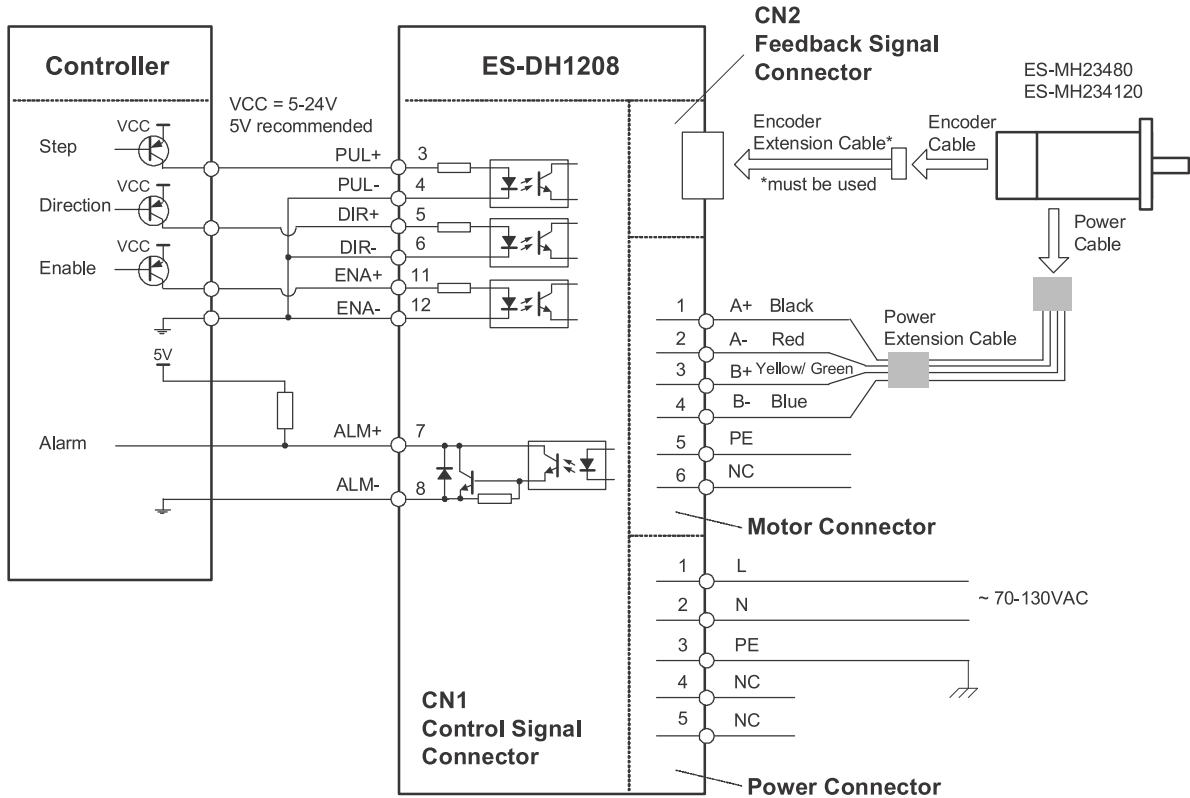

Connection to controller of sourcing output



Software Manual of the Easy Servo Drives

ES-D508, ES-D808, ES-D1008, ES-D1208 & ES-D2306

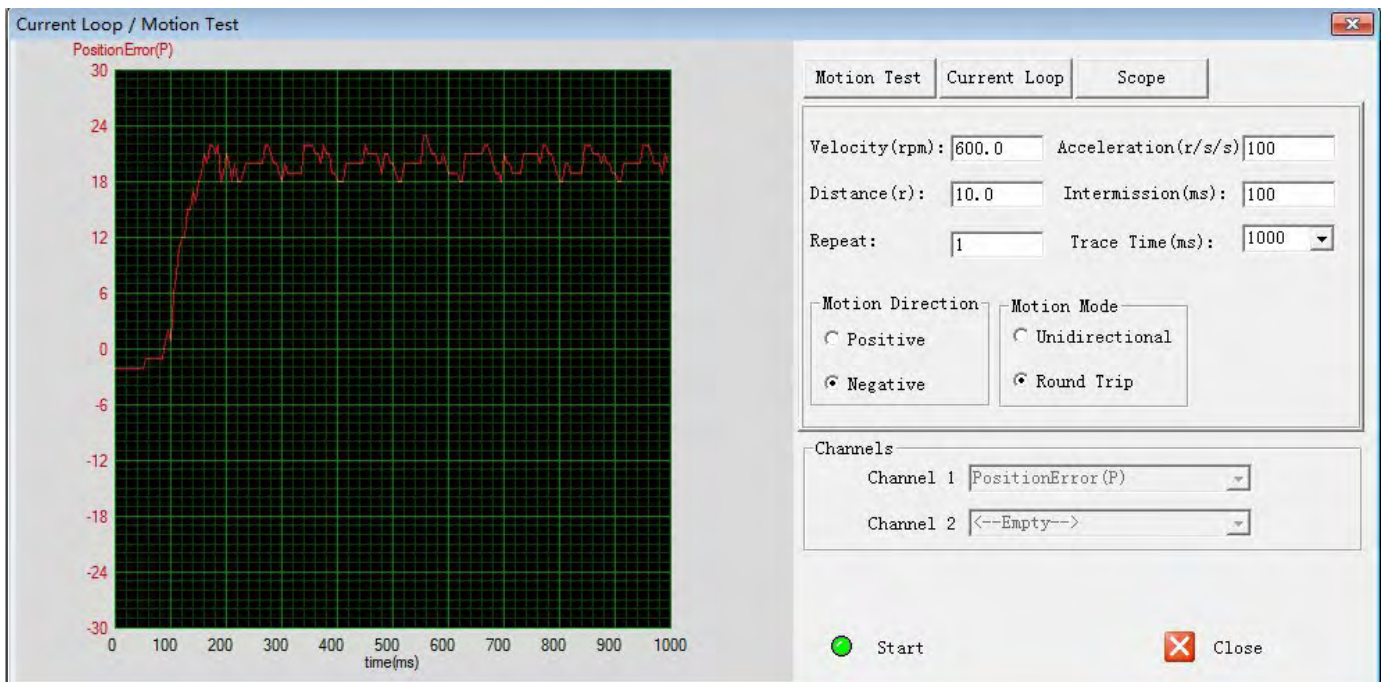

Introduction

The ProTuner is a setup-software that is designed to configure and tune Leadshine's easy servo drives including ES-D508, ES-D808, ES-D1008, ES-DH1208 and ES-DH2306. Users can configure the drive's output current, micro step resolution, command type, tune the current loop and adjust the position loop parameters in this software.

Workspace









Menus and Toolbar

Menus and toolbars are at the top of the workspace. You can click menu bar to view pull-down menu. The toolbar below the menu bar offers the most frequency commands.



Menus and Toolbar (Continued)

Menu	Pull Down	Toolbar	Function
Projects ->	Connect to Drive		Open the serial port and connect to drive
	Exit	-	Exit from ProTuner
Drive Settings->	Inputs / Outputs		Set the command type, active level of the I/O signal.
	Current Loop / Motion Test		Tune the current loop and perform Motion Test.
	Save Drive Parameters		Write the parameters to the drive's NVM (Non-volatile Memory).
	Reset	-	Reset all settings.
Motor Settings->	Motor Settings		Set micro step resolution, position following limit and encoder resolution.
Tools->	Drive Parameters		Download / upload data between the ProTuner and the drive. Or you can also save parameters to a file and restore parameters from a file.
	Alarms		Check drive alarms
About->	ProTuner Information		Display ProTuner information



Using the Software

Connecting Drive

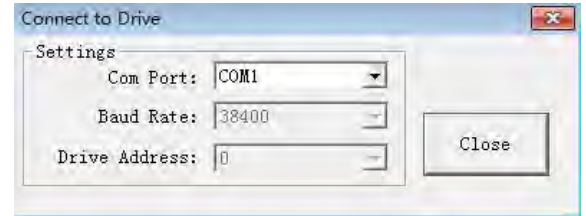
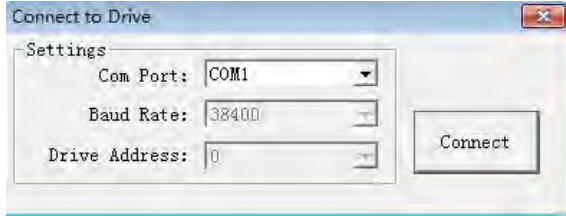

The **Connect to Drive** window will appear when you open ProTuner. You can also open it by clicking **Projects->Connect To Drive** when the software is open. . Select the serial port number and click on the **Connect** button. The software will try to connect to the drive and read the settings. It may take several minutes.



Before connecting the drive, please make sure:

- 1) The RS232 cable .has been connected between the drive and PC serial port.
- 2) Power has been applied to the drive and the green LED is turned on.

Connect to the motor is not necessary if you just want to change the parameters.



Do not connect or disconnect serial cable when drive is powered on. The drive s communication circuit may be damaged.

Inputs/Outputs Window

Click **Drive->Inputs/Outputs** to open the inputs/outputs configuration window. In this window, you can select the active edge of the pulse input, control mode, the active impedance of the In-position output, the active impedance and fault output and the active level of the enable input. Click **Download** to update the parameters on-line.

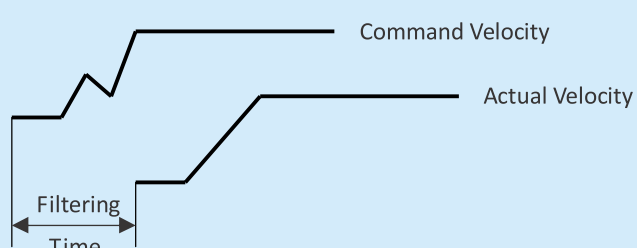

Inputs/Outputs Window (Continued)

Item	Description	Value
Active Edge	Pulse active edge. The motor shaft moves one micro step on each active edge of the pulse.	Rising /Falling
Pulse Mode	Pulse mode of control signal. Select PUL/DIR or CW/CCW according to command type of motion controller. PUL/DIR means pulse and direction mode; CW/CCW means double pulses mode.	PUL/DIR CW/CCW
Fault Output	Active impedance of the fault output. Active High means the impedance between ALM+ and ALM- is high when the drive goes into fault.	Active High / Active Low
Enable Control	Specify the active level of the enable input.	Low level / High level
Filtering Enable	Enable / Disable the internal command filter (or smoother). Note that it will enable the internal command filter.	-
Filtering Time	<p>The time to smooth the command.</p> 	50-25600 us



Current loop / Motion Test Window

Click **Drive->Current loop/ motion test window** to open this window. You can adjust the current loop Kp (proportional gain) and Ki (integral gain) in this window. You can also rotate the motor shaft in this window.

Motion Test Tab

In the Motion Test tab, you can make the motor move without an external motion controller. Set the trapezoidal velocity profile first and then click the **Start** button.

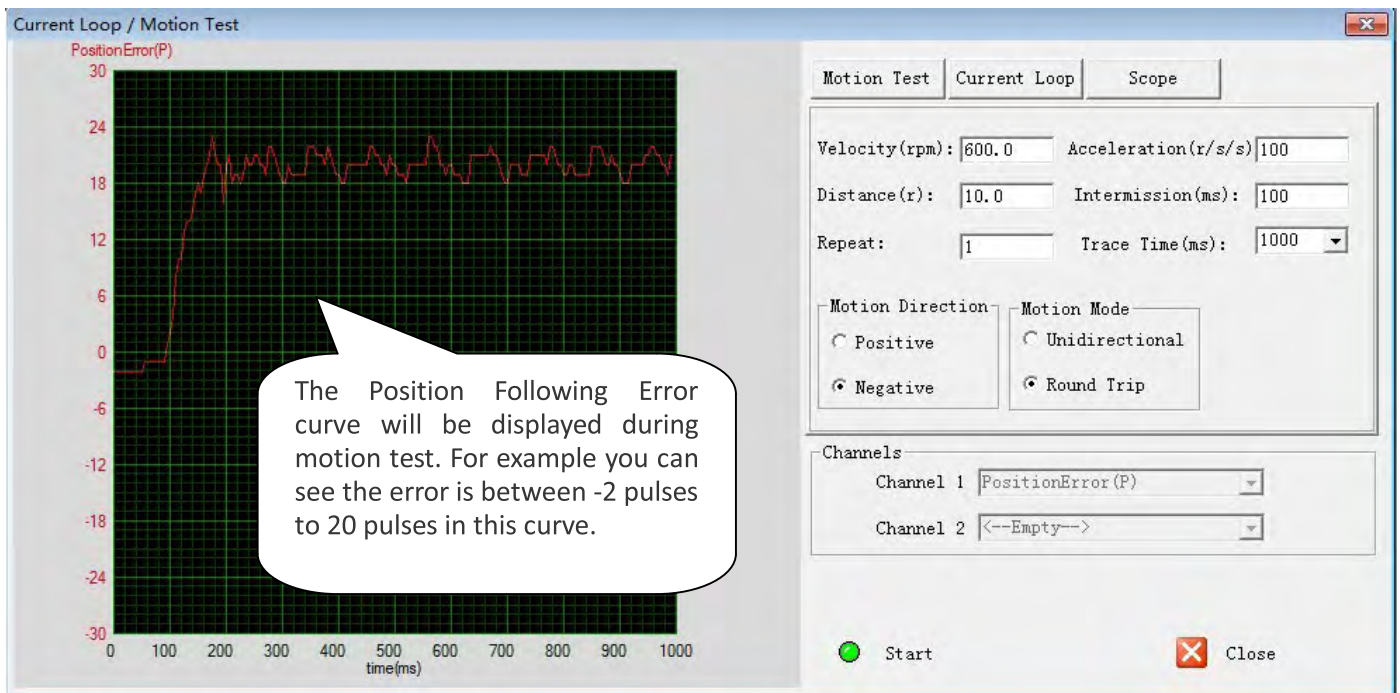

Motion Test Tab (Continued)

Illustration to the parameters in the motion test tab

Item	Description	Value
Velocity (rpm)	Target velocity of Motion Test.	1 – 5000 rpm
Acceleration (r/r/s)	Acceleration of Motion Test.	1 – 3000 r/s ²
Distance (r)	Move distance of Motion Test.	1 – 655 r
Intermission (ms)	Interval between moves.	1 – 10000 ms
Repeat	Repeat times.	1 – 65535
Motion Direction	Move direction of the motion.	Positive/ Reversal
Motion Mode	Motion Test mode includes single direction motion or two direction motion. Unidirectional: Run in one direction, Round Trip: Run forward and back	Unidirectional / Round Trip
Trace Time	The time to sample the position following error data.	100 – 3000 ms
Start	Click to start the Motion Test.	-
Stop	Stop the move immediately.	-
Close	Close the Current / Motion test window	-

The following figures illustrate how the trapezoid motion profile is constructed:

1. Motion Mode: Round Trip

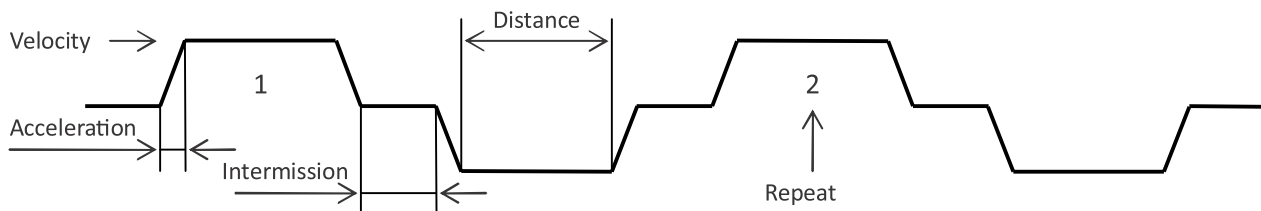

2. Motion Mode: Unidirectional

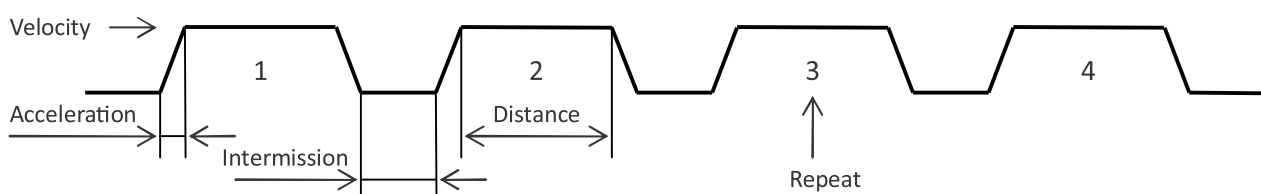

Current Loop Tab

Click **Current Loop** tab to open this window. The current loop parameter is related to the motor resistance and inductance.



If the **Current loop Auto-configuration** is checked, the Kp and Ki will be calculated automatically at power-up. In such case this window is just for check for them. The result of the **Current loop Auto-configuration** is good enough for most of the application.

Current Loop / Motion Test

Motion Test Current Loop Scope

Kp: 3035

Ki: 385

I_Test: 0.5 (A)

Current loop Auto-configuration

Channels

Channel 1 CurrentFeedback (mA)

Channel 2 <--Empty-->

Start Close



Current Loop Tab (Continued)

Illustration to the current loop parameters Kp and Ki

Item	Description	Value
Current Loop Kp (Proportional Gain)	Increase Kp to make current rise fast. Proportional Gain determines the response of the drive to current setting command. Low Proportional Gain provides a stable system (doesn't oscillate), has low stiffness, and large current error, causing poor performances in tracking current setting command in each step. Too large proportional gain values will cause oscillations and unstable systems.	0 – 32766
Current Loop Ki (Integral Gain)	Adjust Ki to reduce the steady error. Integral Gain helps the drive to overcome static current errors. A low or zero value for the Integral Gain may have current errors at rest. Increasing the integral gain can reduce the error. If the Integral Gain is too large, the systems may hunt (oscillate) around the desired position.	0 – 32766
I-Test (A)	The current amplitude for the step response test. Do not exceed the maximum output current of the drive.	0.5A to 5A
Start	Enter Kp, Ki then click this button to activate the test. A target curve (red) will be displayed on the screen for user analysis.	-



Scope Tab

Click **Scope** tab to open this window. You can check the position following error in this window. When the users run the easy servo system in real applications, this window helps to check the performance.

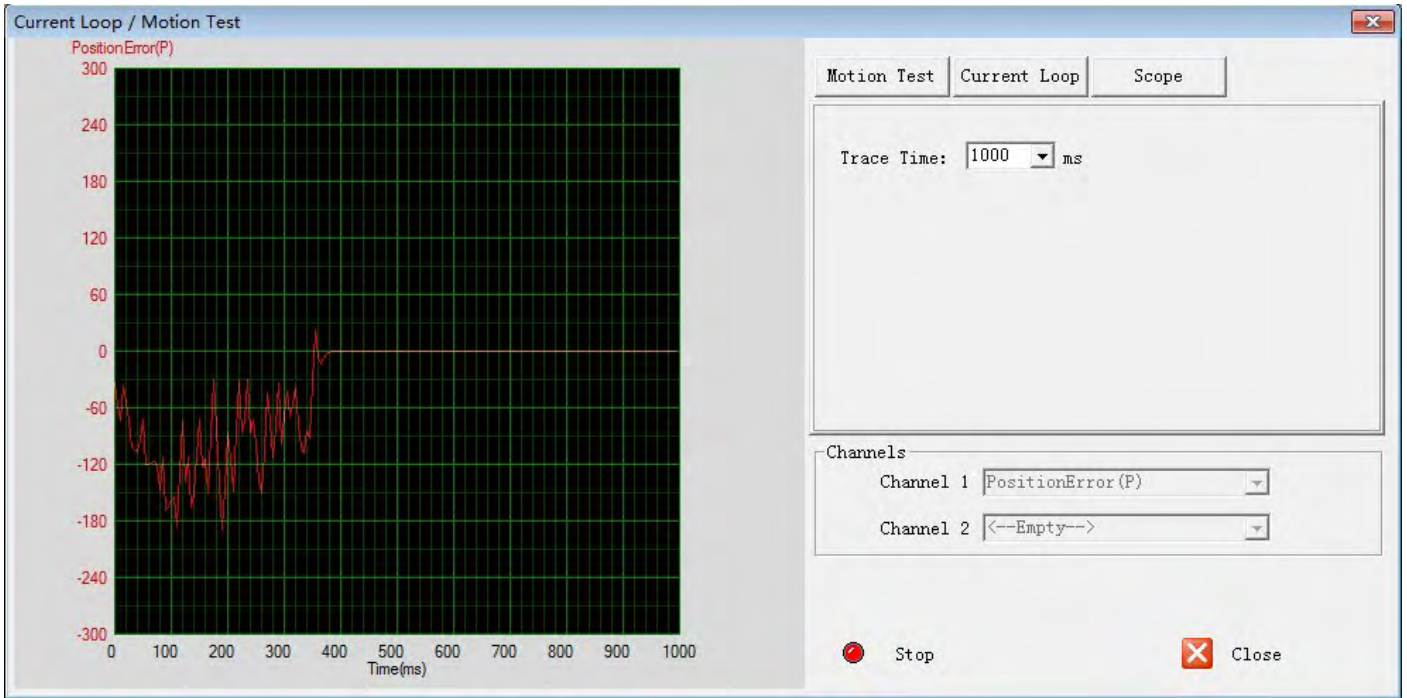

Illustration to the scope parameters settings

Item	Description	Value
Trace Time	The time to sample the position following error. For example, if the trace time is 1000ms, the drive board acquires the position following error data every 1000ms.	100-3000ms
Channel	Select the display signal for each channel. It is depending on the drive model that which curves are available.	-
Start	Start to monitor and display the curves.	-
Stop	Stop monitoring.	-



Save Drive Parameters

The parameter values are only loaded to the drive board's RAM when you change them in ProTuner. After power-off, they will be lost. So you need to click **Drive Settings->Save Drive Parameters** to save all parameters to the drive board's non-volatile memory.

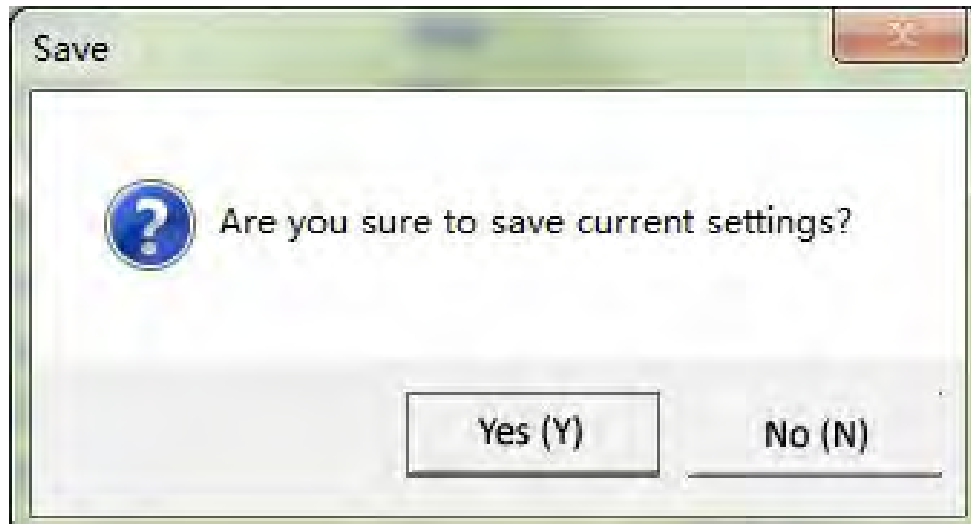

Reset

It is possible that the parameter value is changed unexpectedly and you want to restore the default value. You can click **Drive Settings->Reset** for this purpose. The following confirmation window will appear.

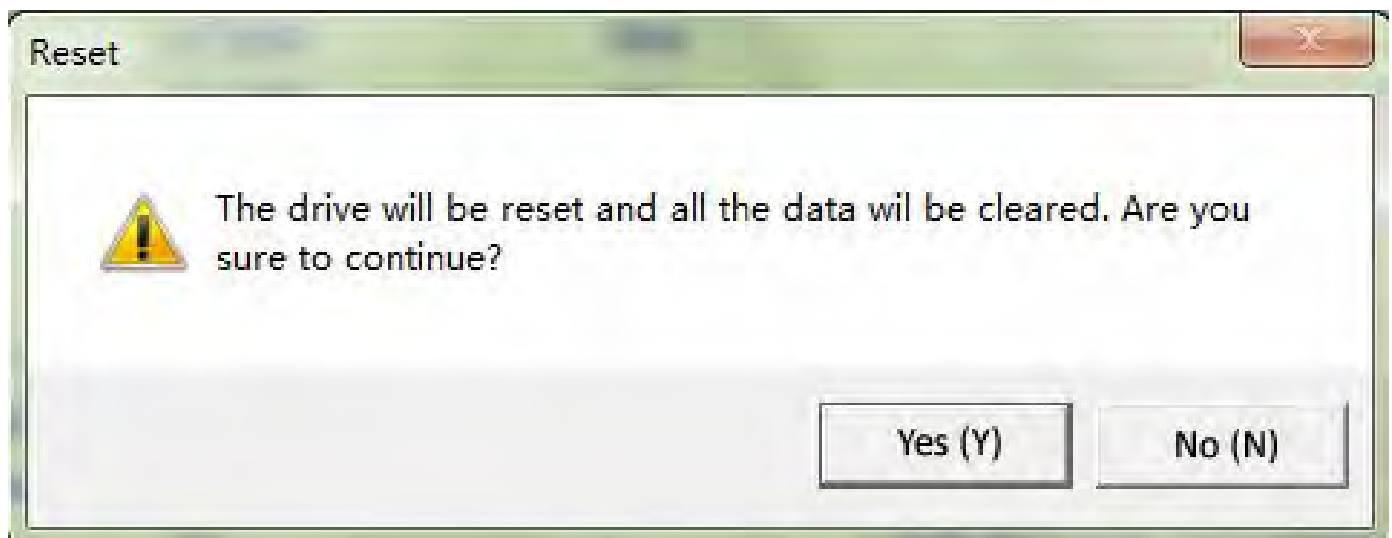

Motor Settings Window

Click **Drive->Motor Settings** to open this window. You can set the micro step resolution, position following error limit and encoder resolution in this window.

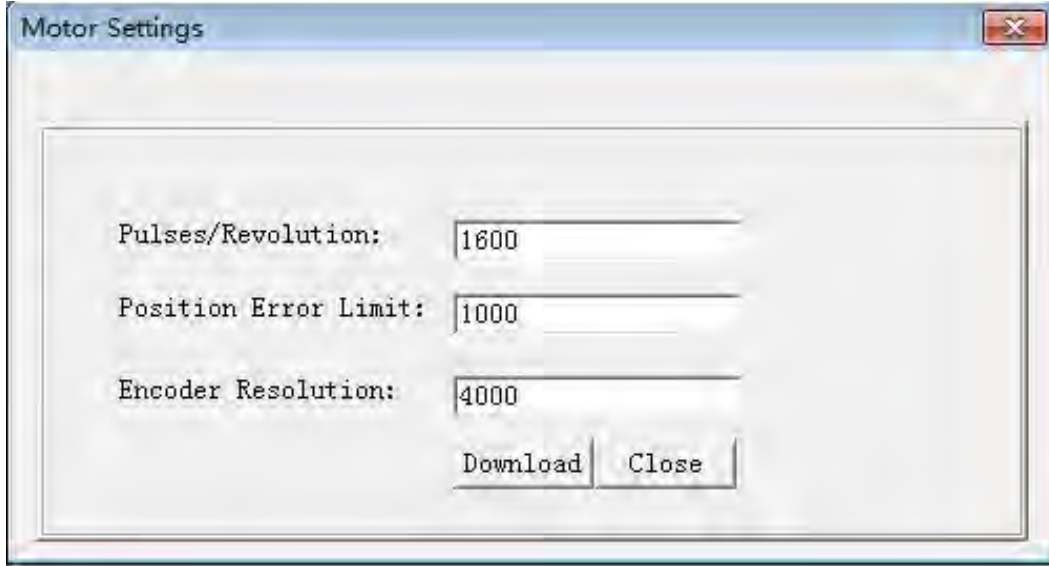

Illustration to the motor settings

Item	Description	Value
Pulse / Revolution	Drive s micro step setting for the motor. It can be set from 200-51200 by step 1.	200 - 51200
Position Error Limit	The limit of the position following error. When the actual position error exceeds this value, the drive will goes into error mode and the fault output will be activated.	0 - 65535
Encoder Resolution	Enter a value equals to 4 times of number of lines of the encoder. For example, if the encoder is a 1000-line encoder, it is 4000. Note: Do not change the default value 4000 is for Leadshine standard easy servo motors.	200-51200



Parameters Window

Click **Tools->Parameters** to open the parameter operation window.

Read Drive

Click "Read drive" button to upload all parameters from the drive. Double click the value of a parameter, you can change that value. Most of the parameters can be found in other windows of this setup software. The parameters only appears in this window are not recommended to change.

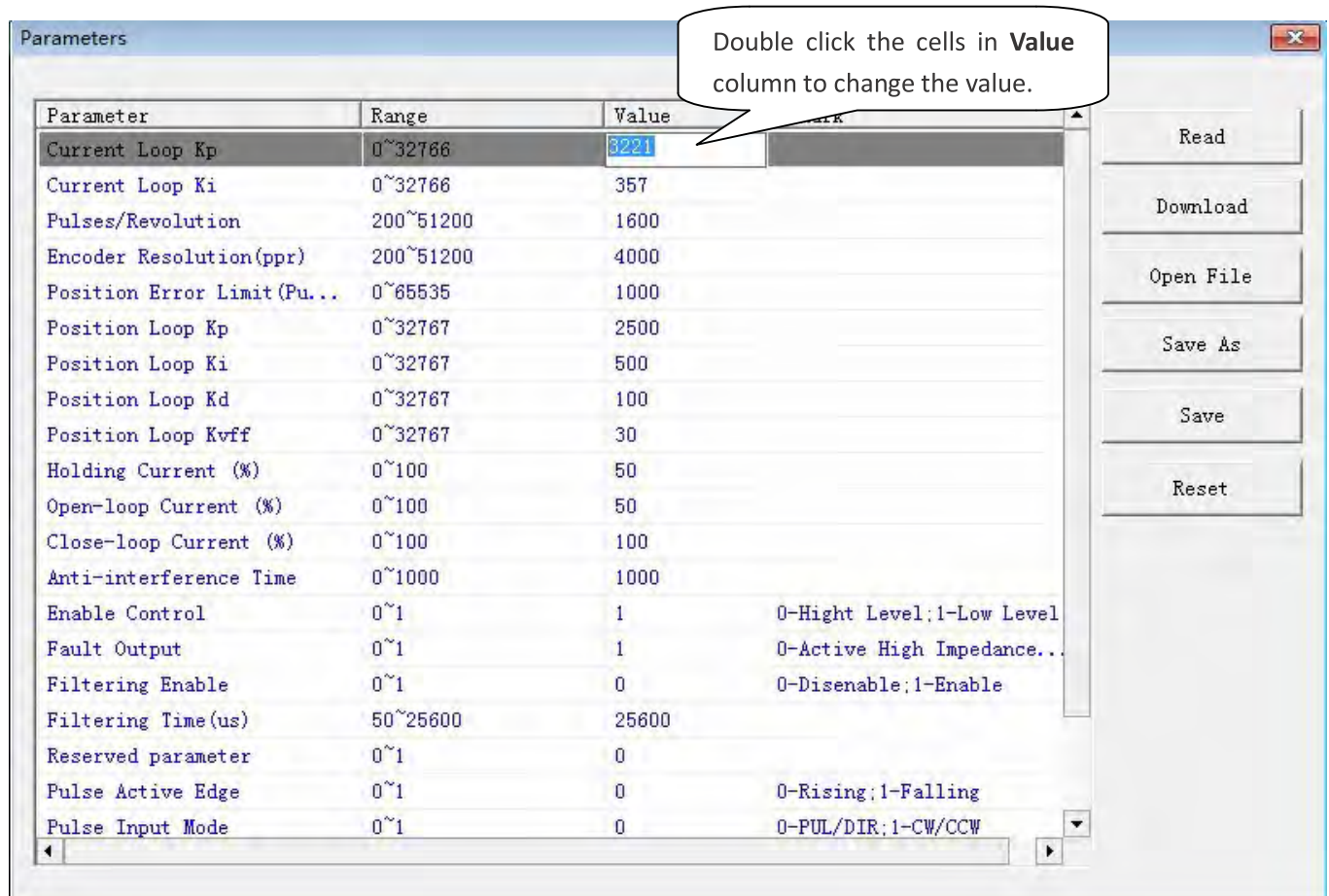

Double click the cells in Value column to change the value.

Parameter	Range	Value	
Current Loop Kp	0~32766	3221	
Current Loop Ki	0~32766	357	
Pulses/Revolution	200~51200	1600	
Encoder Resolution(ppr)	200~51200	4000	
Position Error Limit(Pu...)	0~65535	1000	
Position Loop Kp	0~32767	2500	
Position Loop Ki	0~32767	500	
Position Loop Kd	0~32767	100	
Position Loop Kvff	0~32767	30	
Holding Current (%)	0~100	50	
Open-loop Current (%)	0~100	50	
Close-loop Current (%)	0~100	100	
Anti-interference Time	0~1000	1000	
Enable Control	0~1	1	0-Hight Level;1-Low Level
Fault Output	0~1	1	0-Active High Impedance...
Filtering Enable	0~1	0	0-Disenable;1-Enable
Filtering Time(us)	50~25600	25600	
Reserved parameter	0~1	0	
Pulse Active Edge	0~1	0	0-Rising;1-Falling
Pulse Input Mode	0~1	0	0-PUL/DIR;1-CW/CCW

Download

Click **Download** button to apply the changes.

Open File

If you want to load parameters from a PC file, click **Open File** button in the **Parameters** Window. The parameters in the software s workspace will be updated.

Save As

Click **Save As** button to save the parameters of current workspace to a file. This file can be used to configure other drives.



Parameters Window (Continued)

Save

Click **Save** button to write the parameters to the drive s nonvolatile memory.

Illustration to the parameters not appeared in other window

Parameters	Description	Value
Position Loop Kp	The PID parameters of the position loop. The default values are suitable for most of the application. You don t need to change them. Contact Leadshine technical support if you have any question.	0 - 32767
Position Loop Ki		
Position Loop Kd		
Position Loop Kvff		
Holding Current (%)	Motor current rate when the motor is at standstill. This parameter affects the holding torque of the motor.	0 - 100%
Open Loop Current (%)	Open loop current rate. It s suitable for most of the applications. You don t need to change the default value.	0 - 100%
Close loop Current (%)	Close-loop current rate. This parameter affects the dynamic torque of the motor.	0 - 100%



Check Errors

You can check the active error or the error log of the drive in this window.

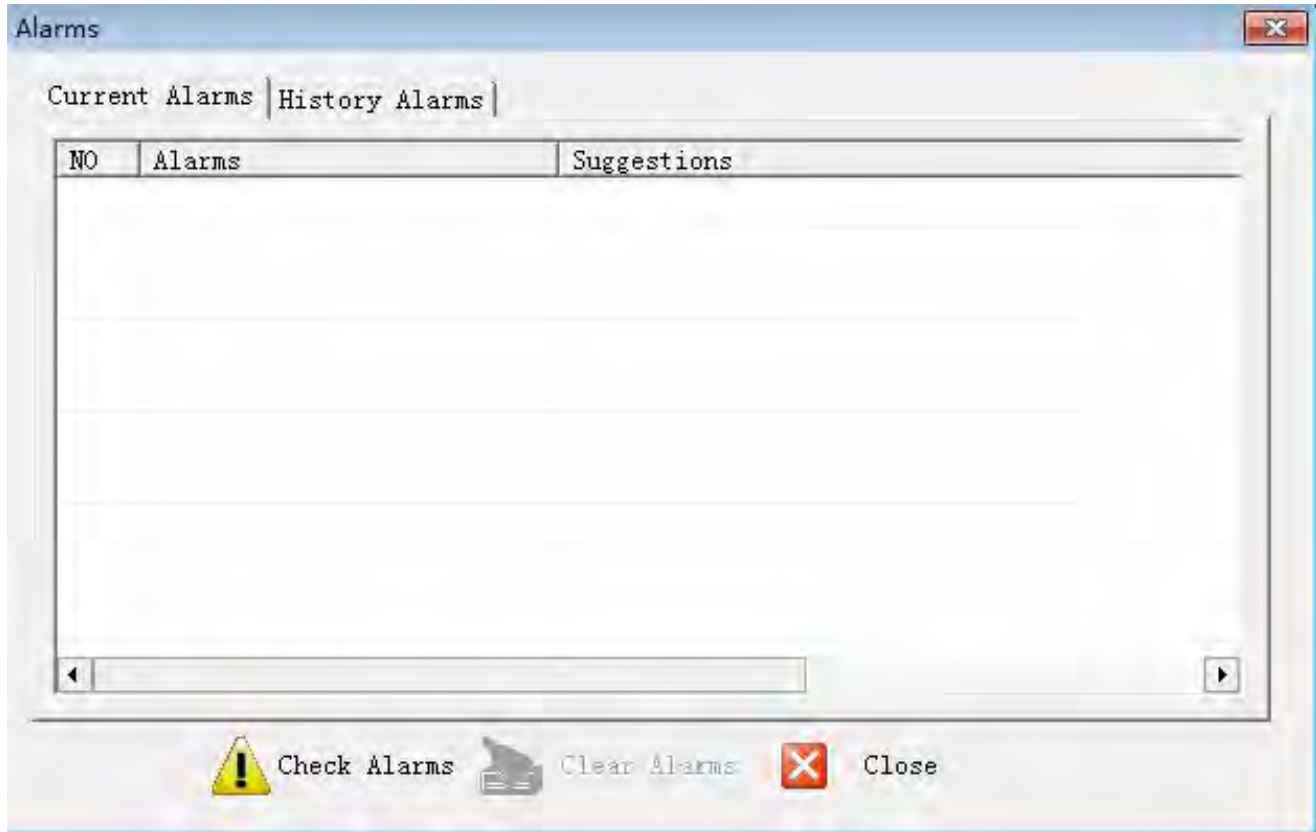

Illustration to the error type

Item	Description
Over Current Error	Error occurs when the motor coil current exceeds the drive s current limit.
Over Voltage Error	Error occurs when the input voltage exceeds the drive s voltage limit
Position Following Error	Error occurs when the actual position following error exceeds the limit which is set by the Position Error Limit .



Configuring the Drive

Typically, you can follow the steps below to configure the drive.

- Step 1:** Set Input/Output parameters such as pulse mode, active edge of pulse, active impedance of fault output, active impedance of the in-position output according to the application.
- Step 2:** Configure motor settings such as micro step resolution, the limit of the position following error.
- Step 3:** Set the holding current and close-loop current which affects the motor torque and speed.
- Step 4:** Manually tune the current loop gain Kp and Ki if necessary.
- Step 5:** Save parameters to Drive's NVM.

Step 1: Configuring Inputs/Outputs

Click **Drive->Inputs/Outputs** to open the inputs/outputs window. You can set the active edge of pulse, pulse mode, the active impedance of fault output and the active level of the enable input in this window. Refer to the **Using the Software** chapter for more information.

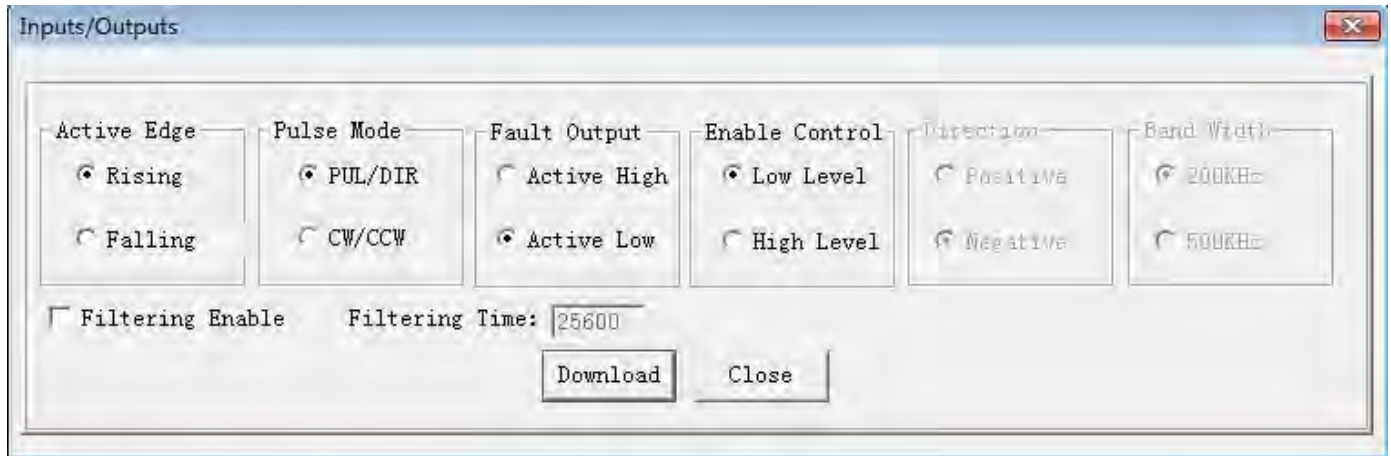

Step 2: Configuring Motor Settings

Click **Drive->Motor Settings** to open the motor setting window. You can set the micro step resolution, position error limit and check the encoder resolution in this window. Refer to the **Using the Software** chapter for more information.

The microstep resolution can be set from 200- 51200. High resolution makes the motor move more smoothly. If the application requires small position following error, reduce the **Position Error Limit**. Usually it is recommended to set it to 1000.



For encoder resolution, do not change the default value of 4000 if you are using Leadshine standard easy servo motors. See related description in page 11 for more information.



Step 2 (Continued): Configuring Motor Settings

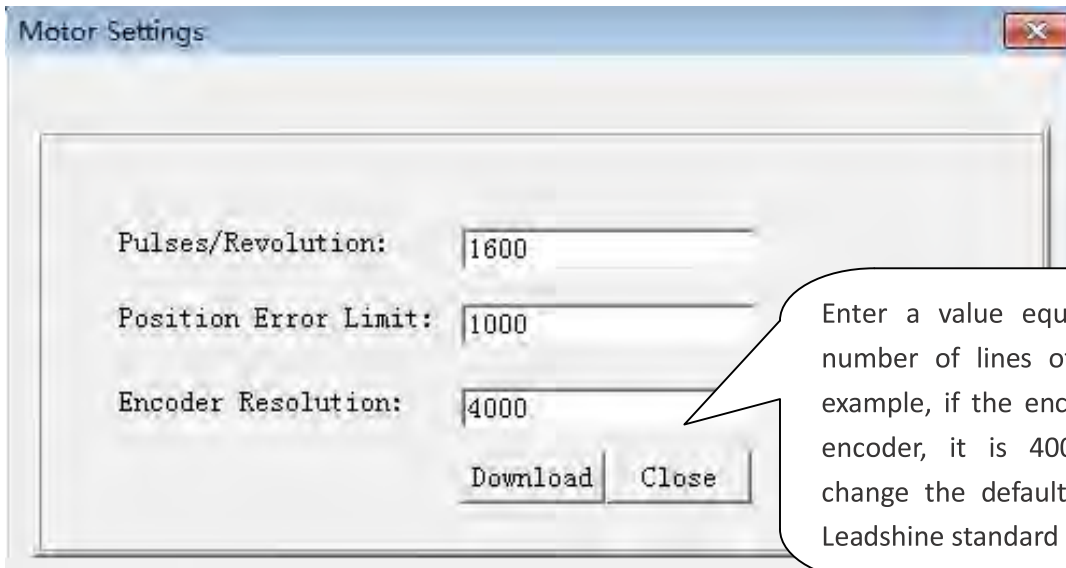

Motor Settings

Pulses/Revolution: 1600

Position Error Limit: 1000

Encoder Resolution: 4000

Download Close

Enter a value equals to 4 times of number of lines of the encoder. For example, if the encoder is a 1000-line encoder, it is 4000. Note: Do not change the default value 4000 is for Leadshine standard easy servo motors.

Step 3: Set Motor Current

When there is no pulse sent to the drive, the easy drive goes into idle mode. The actual motor current is determined by the holding current (similar to idle current of open loop stepper drives). In normal working mode, the easy drive monitors the actual shaft position all the time. The current outputted to the motor changes dynamically based on the tracking error between the actual position and the commanded position.

The actual current outputted to the motor can be calculated as follows:

$$\text{Holding Current} = 6A \times \text{Holding Current (\%)}$$

$$\text{MAX Close loop Current} = 6A \times \text{Close Loop Current (\%)}$$

Low holding current can reduce motor heating however also reduces the holding torque which is used to lock the motor shaft at standstill. It is recommended to determine the holding current by whether or not there is big vibration at start-up and how much lock torque is required, based on your actual applications.

Click the **Tools->Parameters** and the Parameters appears. Click the Read button to get all the parameters from the drive. Double click the value column to edit the parameter.



Step 3 (Continued): Set Motor Current

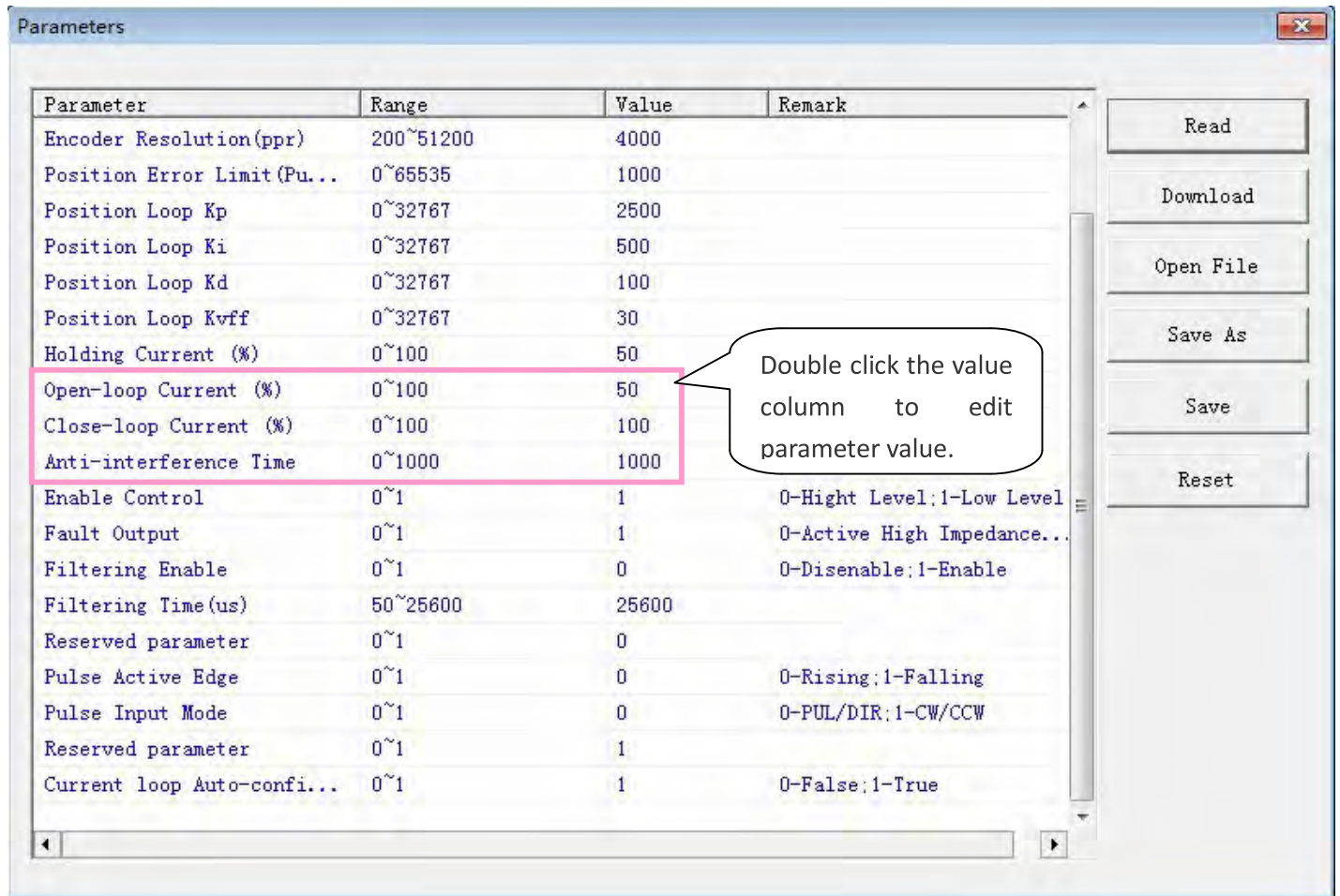

Parameter	Range	Value	Remark
Encoder Resolution(ppr)	200~51200	4000	
Position Error Limit (Pu...)	0~65535	1000	
Position Loop Kp	0~32767	2500	
Position Loop Ki	0~32767	500	
Position Loop Kd	0~32767	100	
Position Loop Kvff	0~32767	30	
Holding Current (%)	0~100	50	
Open-loop Current (%)	0~100	50	
Close-loop Current (%)	0~100	100	
Anti-interference Time	0~1000	1000	
Enable Control	0~1	1	0-Hight Level;1-Low Level
Fault Output	0~1	1	0-Active High Impedance...
Filtering Enable	0~1	0	0-Disenable;1-Enable
Filtering Time(us)	50~25600	25600	
Reserved parameter	0~1	0	
Pulse Active Edge	0~1	0	0-Rising;1-Falling
Pulse Input Mode	0~1	0	0-PUL/DIR;1-CW/CCW
Reserved parameter	0~1	1	
Current loop Auto-confi...	0~1	1	0-False;1-True

Step 4: Tune Kp and Ki of the current loop

Note: The Kp and Ki are auto-configured at power-up when the current loop auto-configuration check box is selected in the current loop window. There is no need to tune them and you can ignore the following steps.

Click the **Drive-> Current Loop / Motion Test** start the tuning. In the open window, the default tab is Motion Test. If you want to tune the current loop Kp and Ki manually, first uncheck the current loop auto-configuration and don't forget to save the change to drive's EEPROM by clicking the **Save** button in the **Parameter** window. Click the **Current Loop** tab and then tune current loop Kp and Ki.



Step 4(Continued): Tune K_p and K_i of the current loop

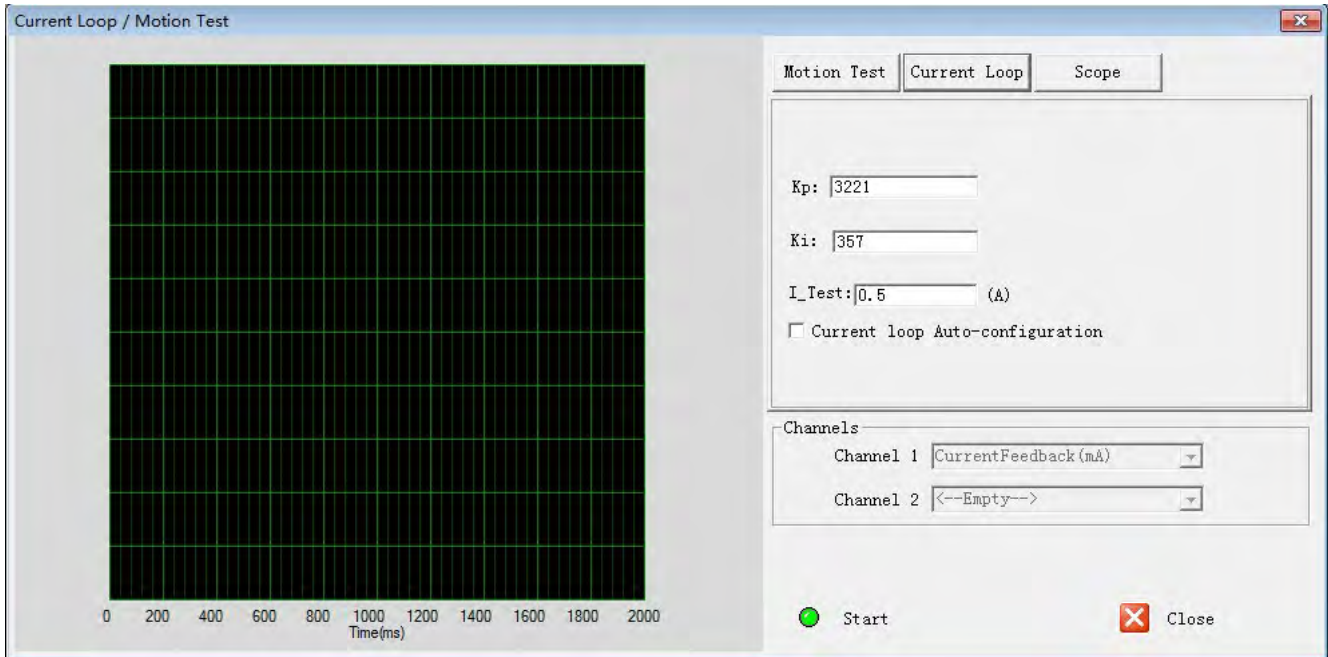

Below is an tuning example based on the ES-D808 and ES-M23440 with 36VDC power supply.

1: Set I_Test to 1 and start the tuning with small K_p and zero K_i . Here we set $K_p=500$ and $K_i=1$. I_Test is the amplitude of the target. Here we set it to 1Amp. I_Test is usually 15%-70% of the motor s rated current.

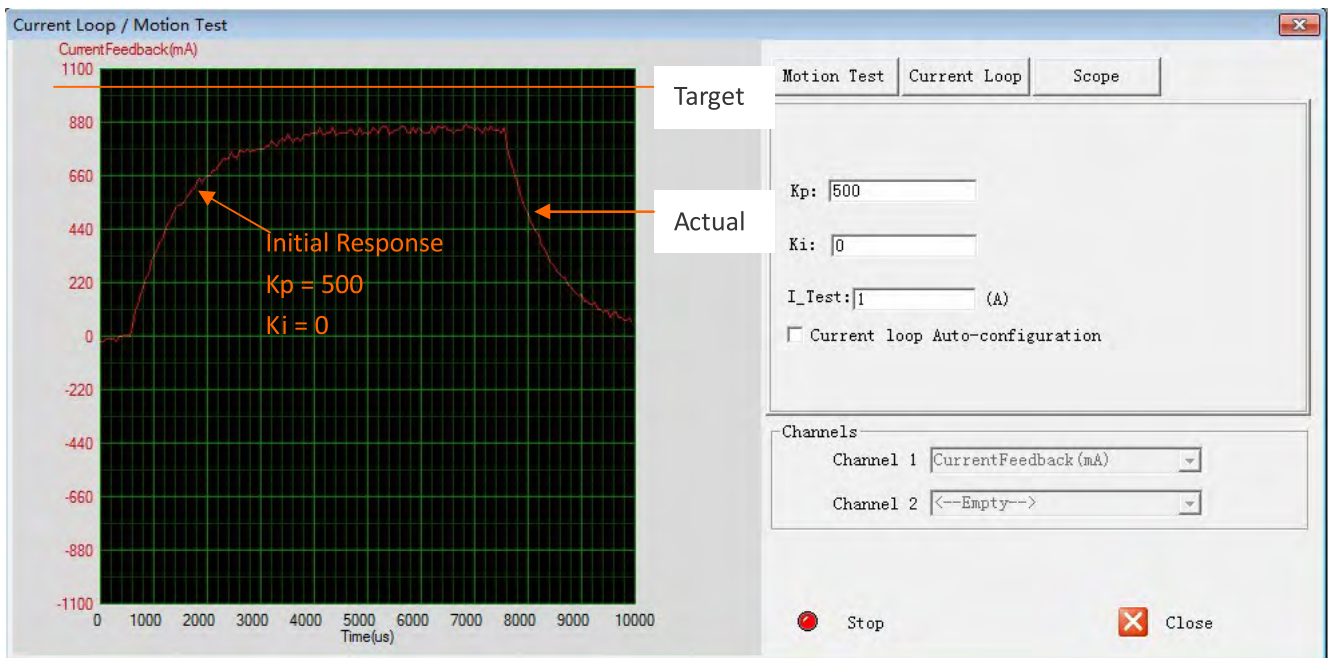

2: Click the **Start** button and the plot window shows the step response of the current test. As the red curve increases from 0 to target slowly, it indicates that a large K_p needs to be introduced.



Step 4 (Continued): Tune Kp and Ki of the current loop

3: Increase **Kp** to 1000 and click **Start**. The red curve change faster from 0 to the target.

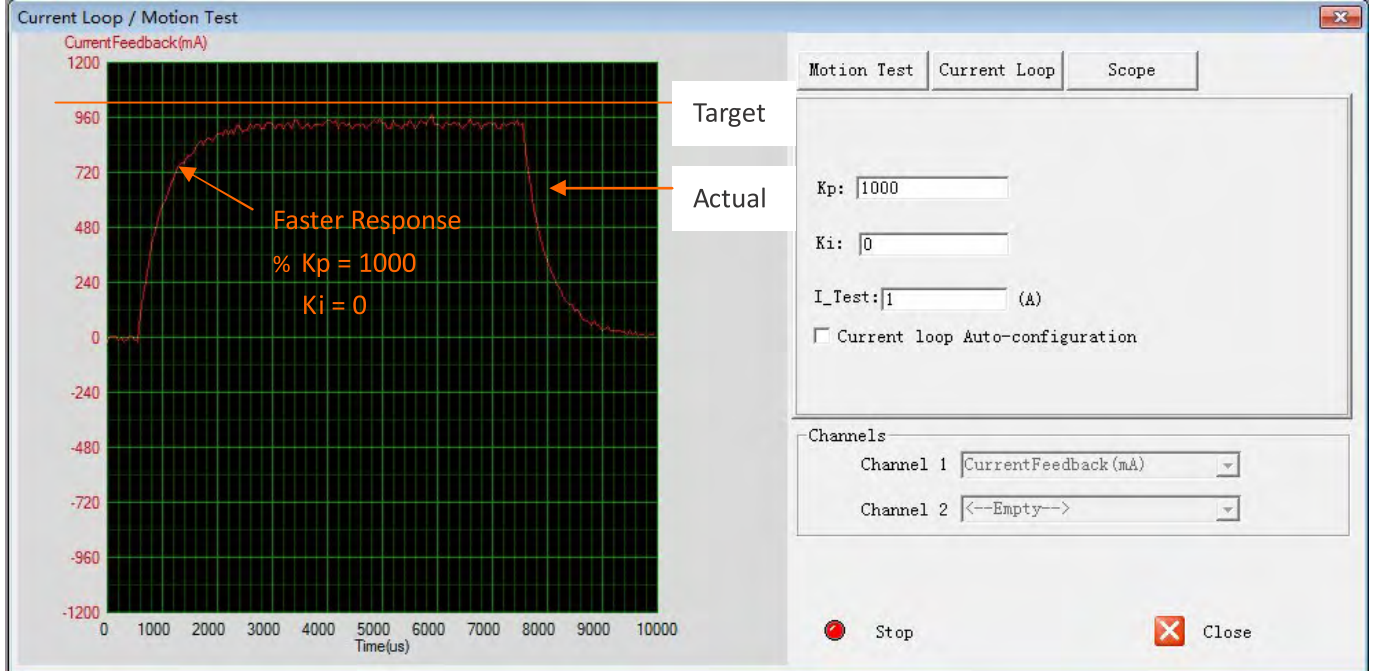

4: Set **Kp** to 2000, 3000 and 5000, respectively. Then click **Start**. The red curve is changing faster and faster. However over-shoot appears when **Kp** is 5000. It indicates that you need to stop increasing Kp and back off. So we decrease Kp to 4000 until the actual value is exactly over the target value.

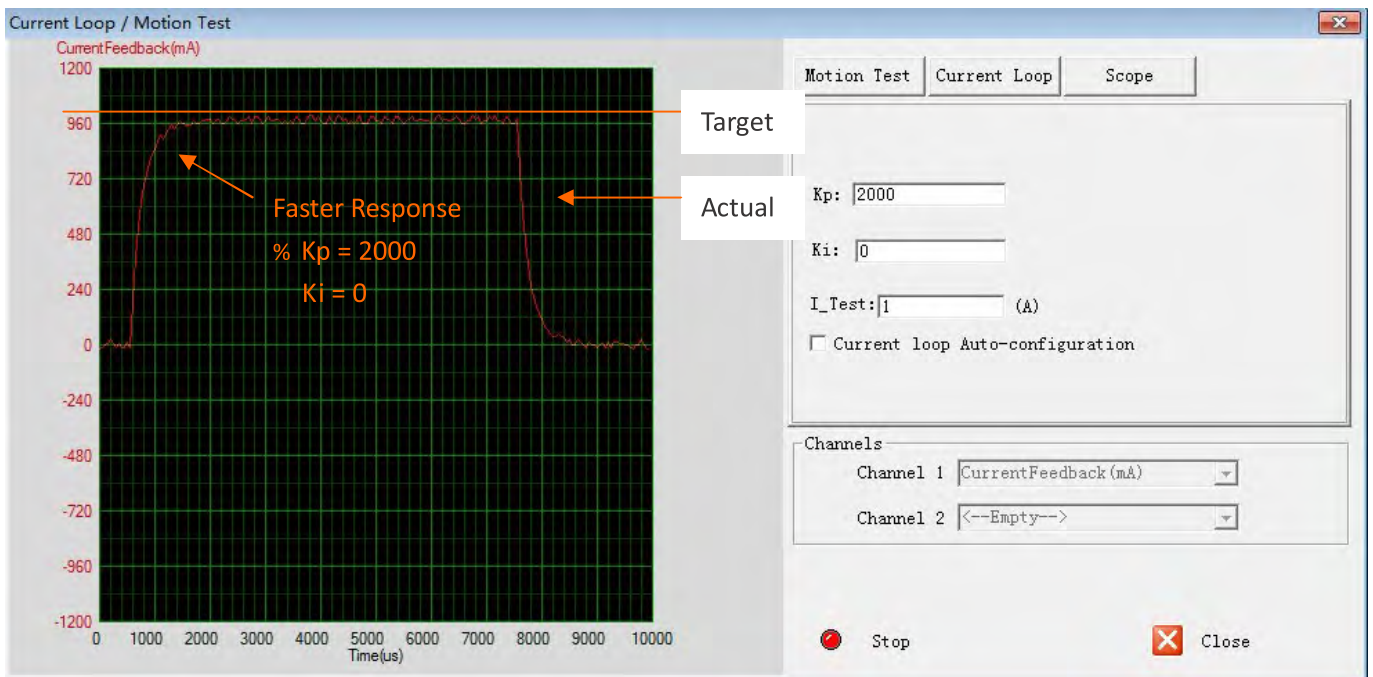

Step 4 (Continued): Tune Kp and Ki of the current loop

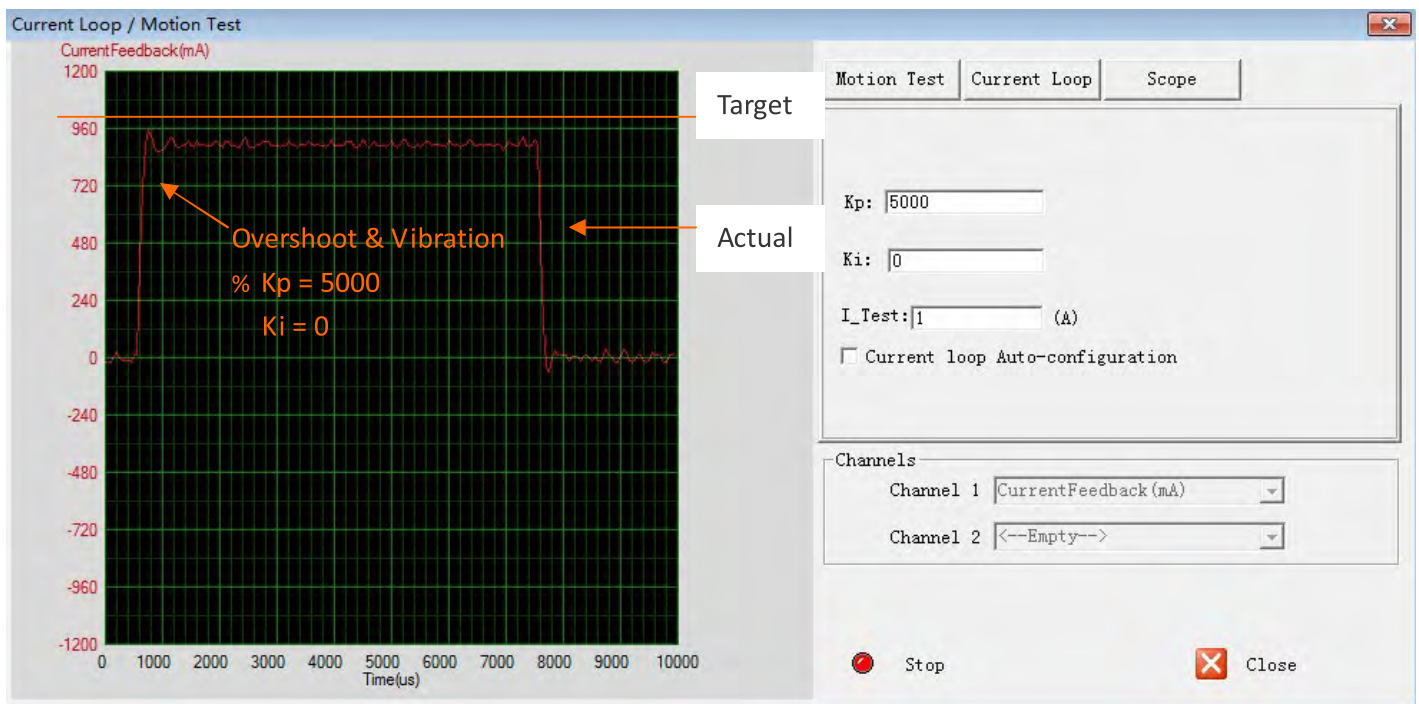
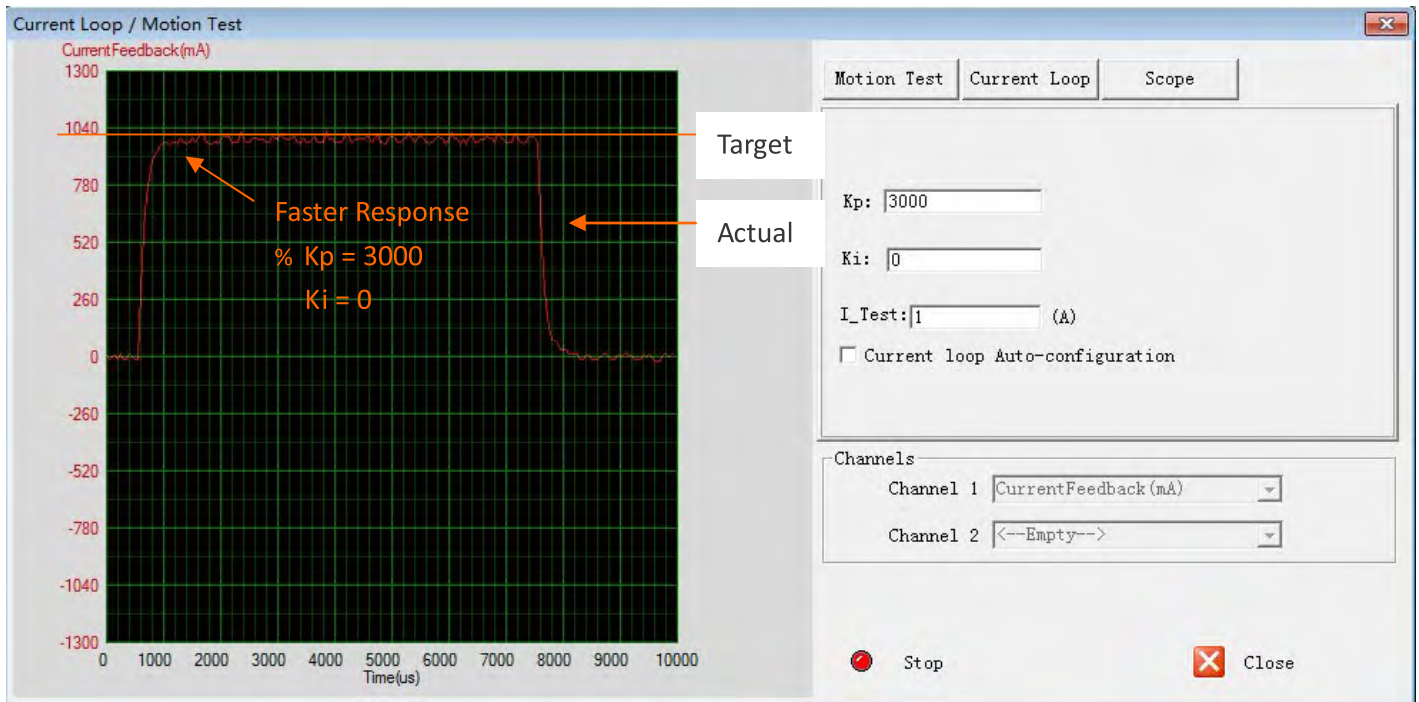

Step 4 (Continued): Tune K_p and K_i of the current loop

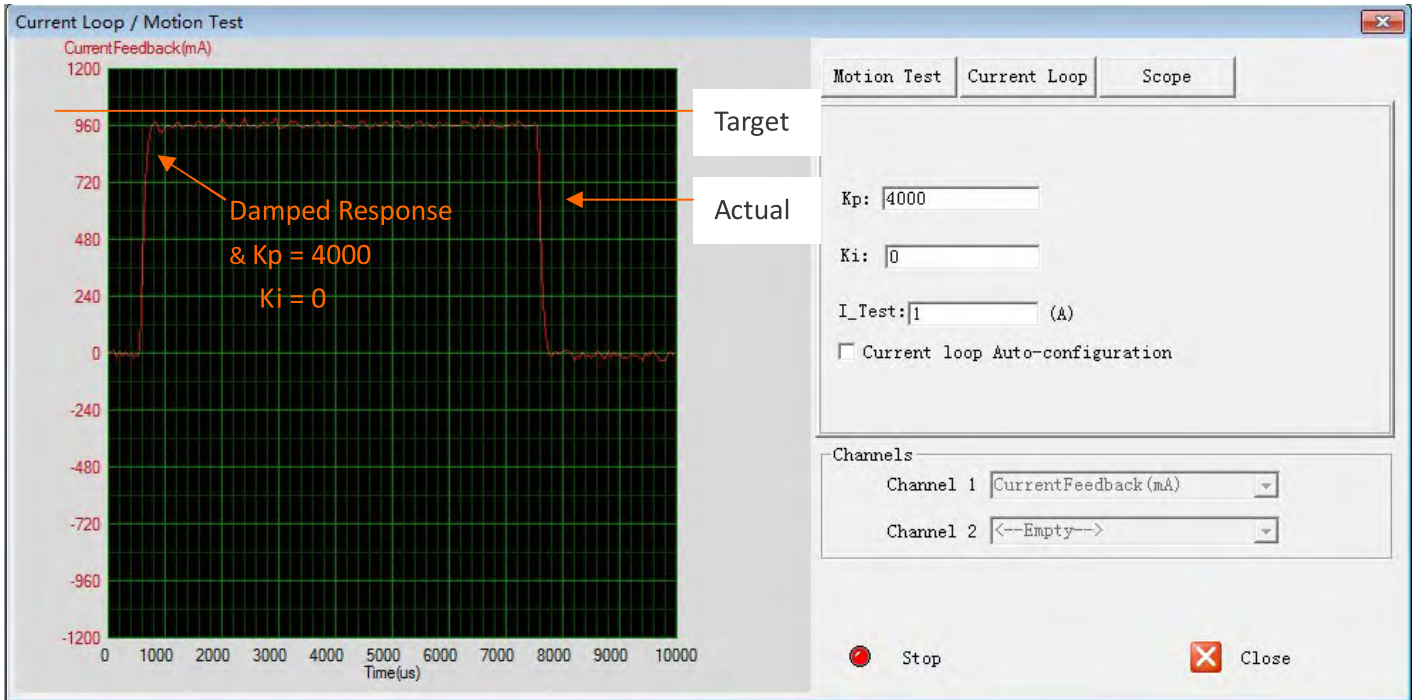

5: Now the K_p is relatively good enough. But there is still error between the actual current and the target current. So we need to introduce K_i to reduce the steady error of the constant part. It follows the same procedure as K_p . High K_i causes big vibration, system lag and makes the performance worse. The following figures show how to tune the integral gain.

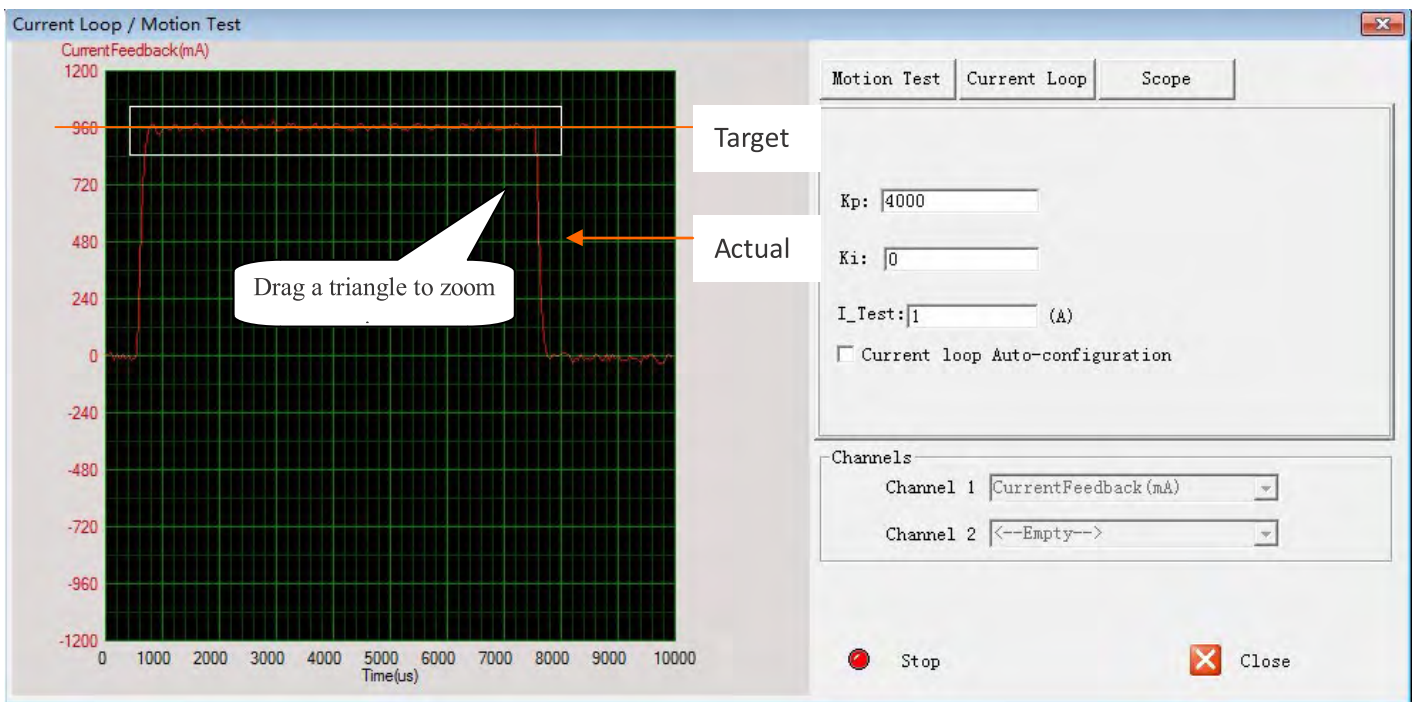

Step 4 (Continued): Tune Kp and Ki of the current loop

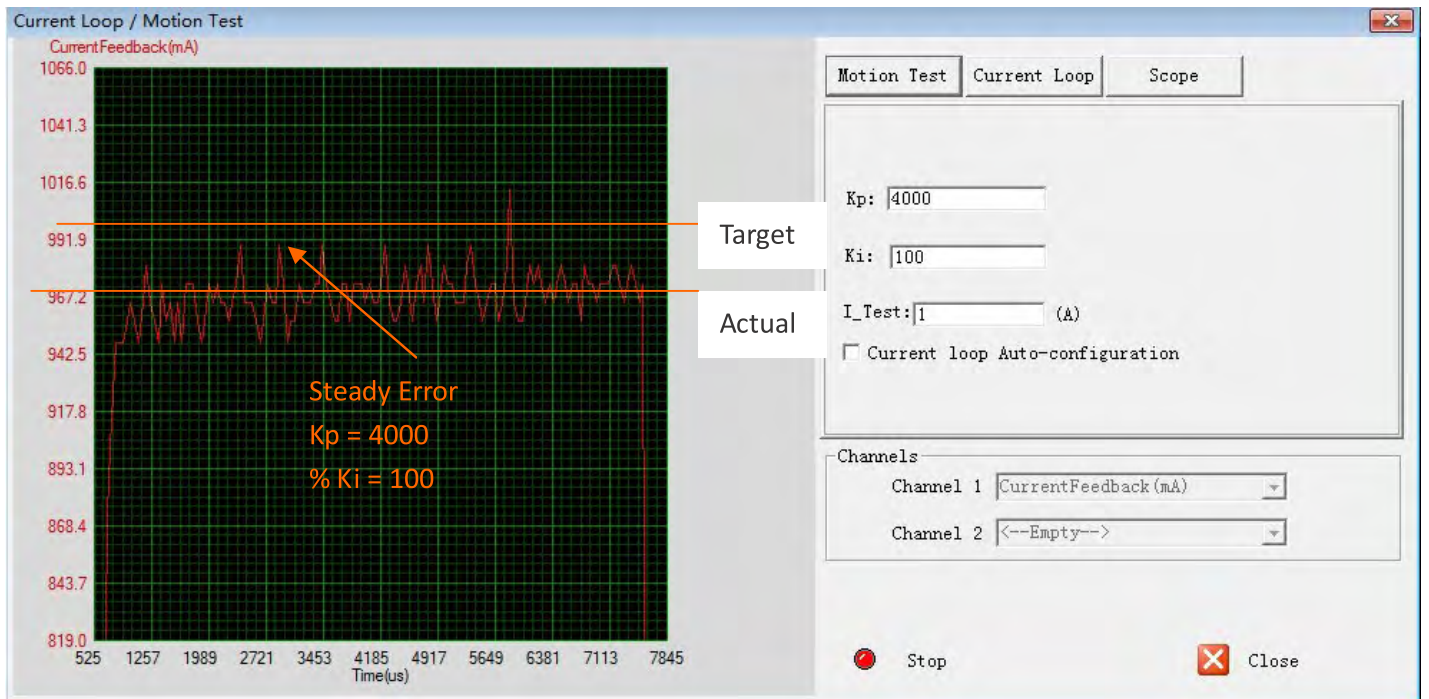
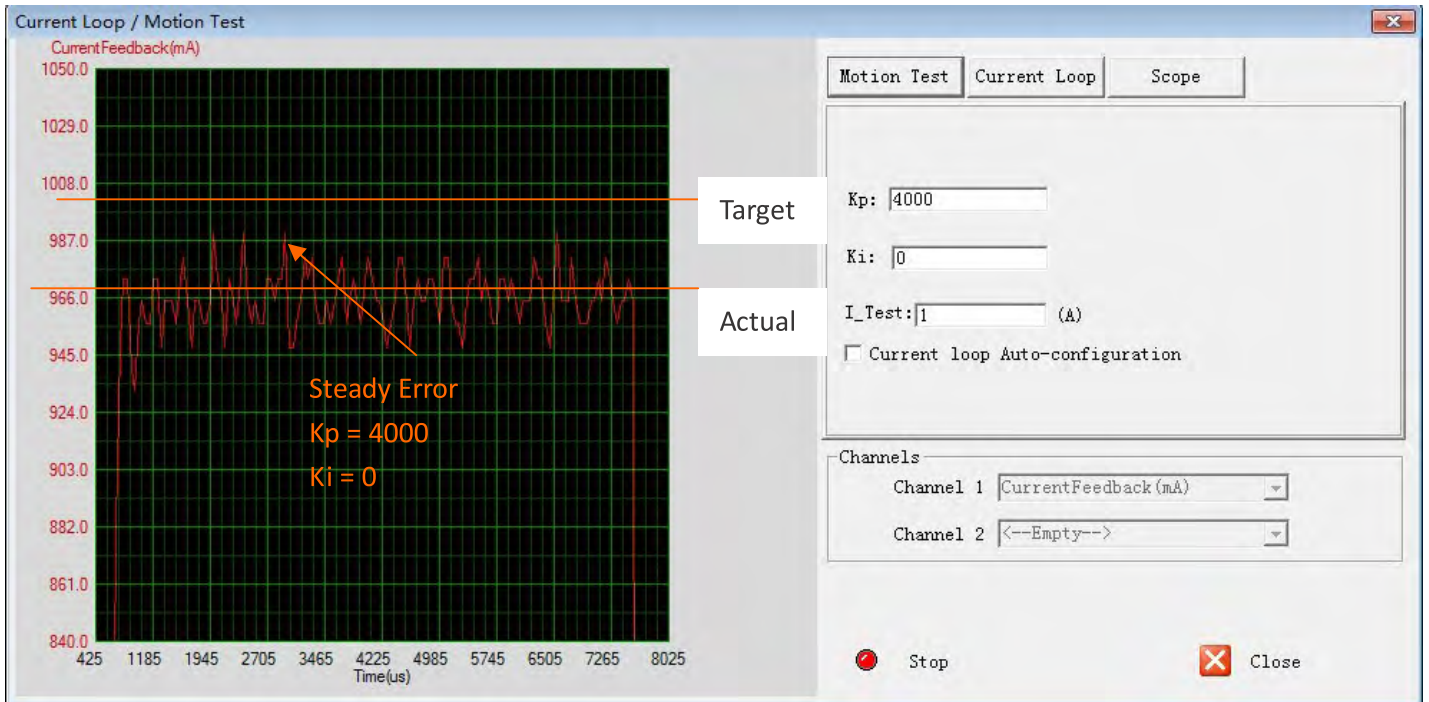

Step 4 (Continued): Tune Kp and Ki of the current loop

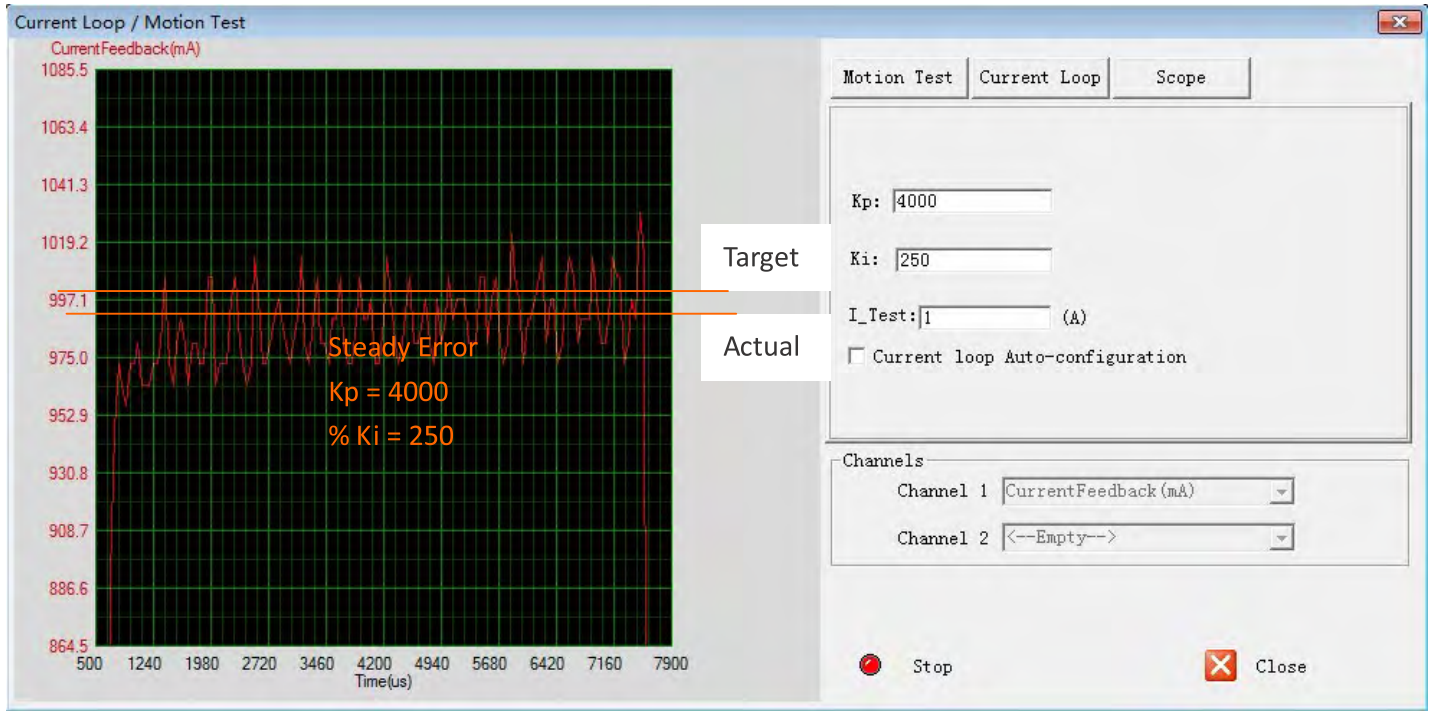

Step 5: Save parameters to drive s NVM

All the parameters are just stored in the driver s RAM. They will be lost when we power off the driver. Don t forget to click the **Save Drive Parameters** icon to store the changed value to the drive s EEPROM. See below.



Save all the changes to the drive s nonvolatile memory.



More about the Position Loop Parameters



Leadshine already loads default current-loop parameters and position-loop parameters. Those default parameter values have been optimized. They should be good enough for most industrial applications, and there is no need to tune them. However, if you want to tune them for best performance for your applications, ProTuner allows you to adjust those parameters



The effect of K_p , K_d , K_i and K_vff is similar as the items in servo control system. But they are not completely the same. The adjustable range of K_p , K_d , K_i and K_vff is from 0-32767. However, do not give too low or high value to these parameters. It is recommended to adjust them by 10%-30%. Otherwise the drive's performance may go bad!

To adjust the position loop parameter, click **Tools->Drive Parameters** to view the parameters. The position loop parameters appear and you can adjust them by the steps as follows:

- 1) Select the row.
- 2) Double click the cell value in Value column. The number will be selected and you can change it.
- 3) Click other place to confirm the input.

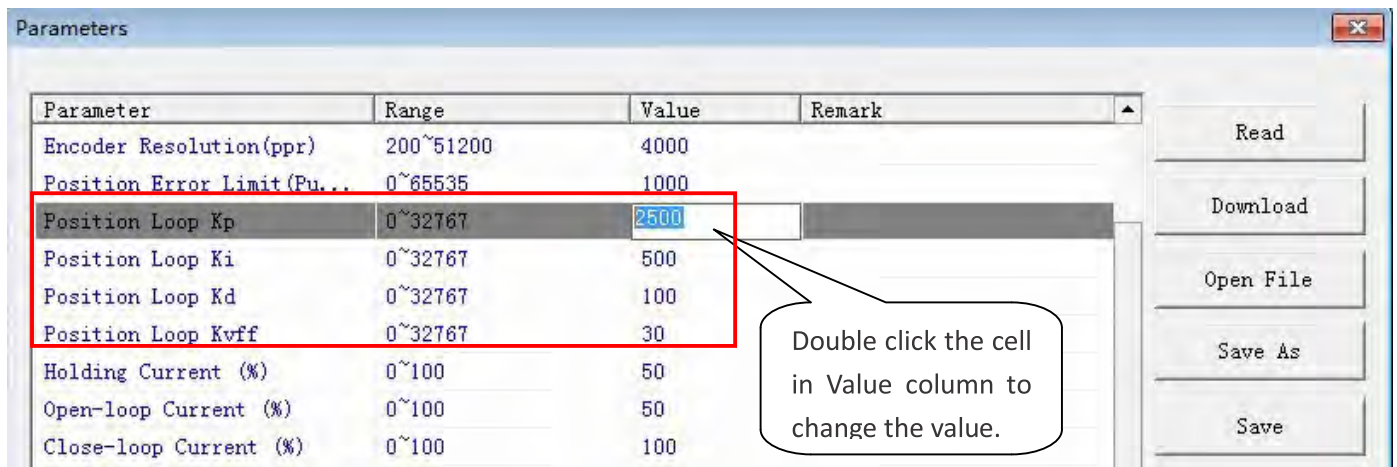

Parameter	Range	Value	Remark
Encoder Resolution(ppr)	200~51200	4000	
Position Error Limit(Pu...)	0~65535	1000	
Position Loop K_p	0~32767	2500	
Position Loop K_i	0~32767	500	
Position Loop K_d	0~32767	100	
Position Loop K_vff	0~32767	30	
Holding Current (%)	0~100	50	
Open-loop Current (%)	0~100	50	
Close-loop Current (%)	0~100	100	

Tuning Tips

Faster Response, High Speed, High Torque, Smooth Move

Increase the K_p , K_d , K_vff , Open-Loop Current and Close-loop Current.

Lower Motor Noise, Lower Motor Heating

Decrease the K_p , K_d , K_vff , Open-Loop Current and Close-loop Current

