

## OBC-60\*60 L سبک

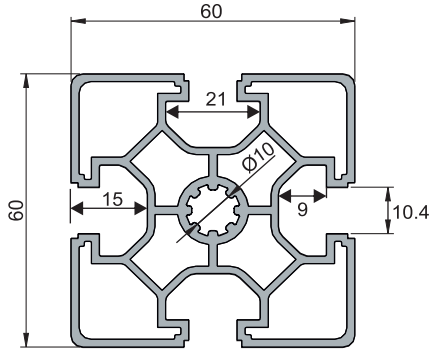

Part No.	Wy cm <sup>3</sup>	Wx cm <sup>3</sup>	Ly cm <sup>4</sup>	Lx cm <sup>4</sup>	L mm	coating	Material	Area cm <sup>2</sup>	Weight kg/m
OBC-60*60 L	9.9	9.9	29.85	29.85	6000	Anodizad	AL-6063	8.8	2.46

L(Standard) : 6050 mm

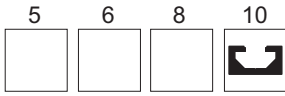

