

Alu Profile Accessories/Connectors/End Connectors

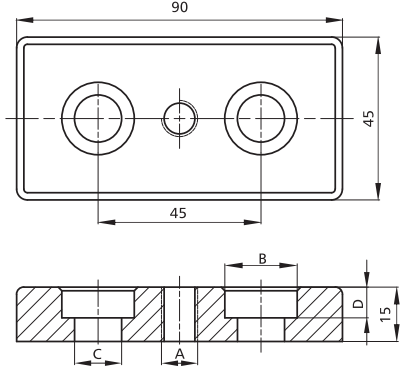

Item No.	A	B	C	D	Material	Finish	PCS/CTN	KGS/CTN	CTN SIZE (mm)
K4590-4-4	M8	Φ 15.5	Φ9(M8)	9	Die-Cast Alu	Dull Polished	80	9.25	225*170*180
K4590-4-5	M10						80	9.20	225*170*180
K4590-4-6	M12						80	9.15	225*170*180
K4590-4-7	M14						80	9.00	225*170*180
K4590-4-8	M16						80	8.90	225*170*180
K4590-6-4	M8	Φ 20	Φ13(M12)	8.5	Die-Cast Alu	Dull Polished	80	8.80	225*170*180
K4590-6-5	M10						80	8.70	225*170*180
K4590-6-6	M12						80	8.60	225*170*180
K4590-6-7	M14						80	8.40	225*170*180
K4590-6-8	M16						80	8.20	225*170*180

