

## OBC-30\*30 H سنگین

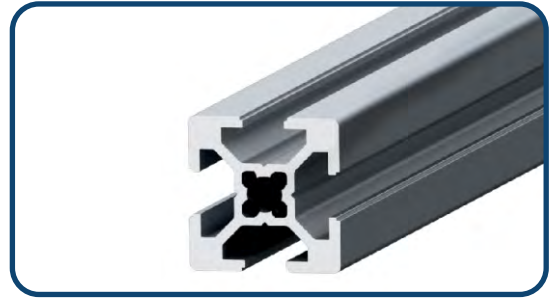

Part No.	Wy cm <sup>3</sup>	Wx cm <sup>3</sup>	Ly cm <sup>4</sup>	Lx cm <sup>4</sup>	L mm	coating	Material	Area cm <sup>2</sup>	Weight kg/m
OBC-30*30 H	1.8	1.8	2.91	2.91	6000	Anodizad	AL-6063	3.22	0.950

L(Standard) : 6050 mm

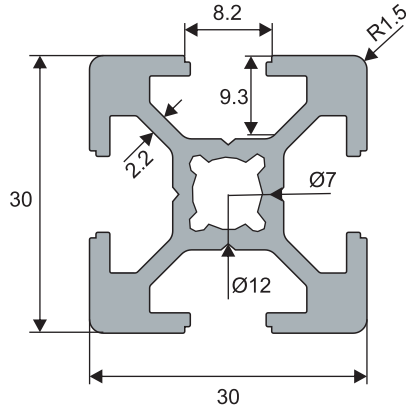
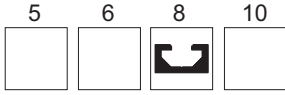

