

711

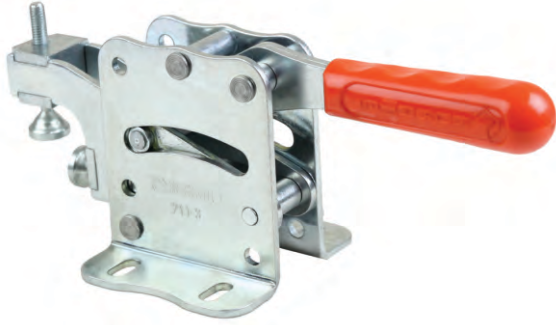

Body Mounting Base Horizontal

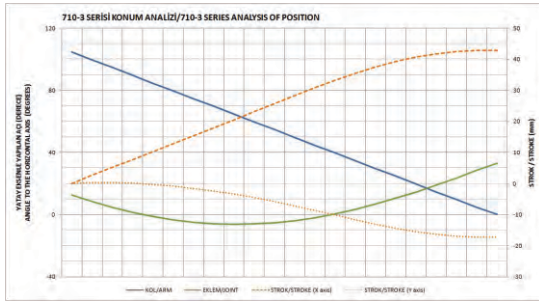

Clamping Positions

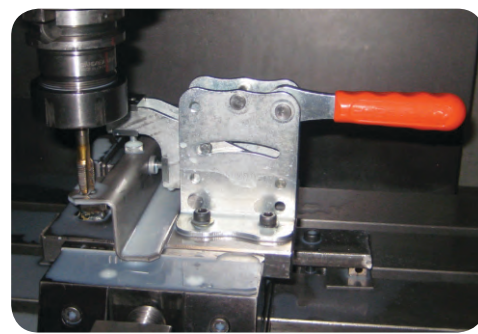
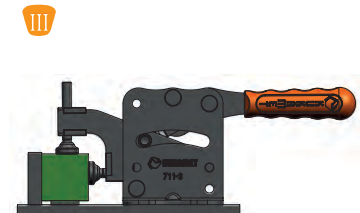
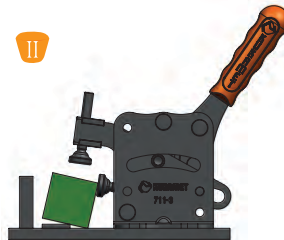
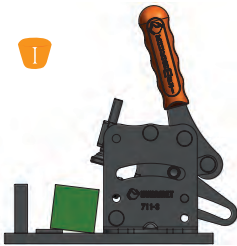

Combination Toggle Clamps

MODEL NO	F1 (N)	F2 (N)	F3 (N)	F4 (N)	Fi		(WEIGHT) (gr)
					VERİM (YIELD) (F1:F2)	VERİM (YIELD) (F2:F1)	
711-1	1000	1000	1000	1000	14:1	8:1	400
711-2	2000	2000	2000	2000	17:1	9:1	790
711-3	3000	3000	3000	3000	19:1	11:1	1690

F1 - F2 : BASKI KUVVETİ (EXERTING FORCE) , F3 - F4 : TUTMA KAPASİTESİ (HOLDING CAPACITY) , Fi : UYGULAMA KUVVETİ (APPLIED FORCE)

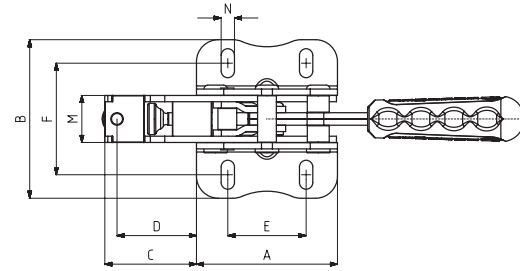
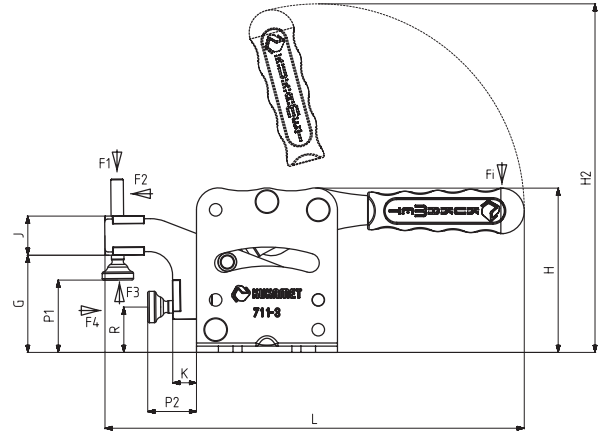

MODEL NO	A	B	C	D	E	F	G	H	H2	J	K	L	M	N	P1 Min.	P1 Max.	P2 Min.	P2 Max.	R
711-1	56	59,5	38	32,5	40	37,5 - 44,5	42	70	148	15	10	173	16	5.5 x 9	15	33	19	37	20,5
711-2	75	79,5	48	41	50	49,5 - 62,5	52	88	186	20	12	223	20	6.5 x 13	24	41	22	39	24,5
711-3	90	101,5	58	50	50	61 - 81	62	105	222	25	15	268	30	8.5 x 18.5	23	49	28	54	29

